

TABLE OF CONTENTS

| | |
|--------------------------------|------|
| INTRODUCTION | p. 3 |
| 1. WHY RUN THE WILD BUNCH? | 4 |
| 2. THE <i>TAO</i> OF DECEPTION | 10 |
| 3. CHOOSING PERSONNEL | 12 |
| 4. SETTING UP THE SYSTEM | 14 |
| 5. FORGING THE LINE | 20 |
| 6. BACKS AND RECEIVERS | 33 |
| 7. QUARTERBACK BASICS | 35 |
| 8. THE PLAYS | 47 |
| THE RUNS | 48 |
| THE PASSES | 86 |
| THE SPECIALS | 124 |
| 9. INSTALLATION | 132 |
| 10. SITUATIONAL WILD BUNCH | 139 |
| 11. A PHILOSOPHY OF ATTACK | 146 |

Dedication:

THIS BOOK IS FOR PATSY, WHOSE PATIENCE DURING THE YEARS I WAS DEVELOPING THE WILD BUNCH WAS MATCHED ONLY BY HER GOOD HUMOR.

Copyright © 2006 Edmond E. Seay III

INTRODUCTION



The Wild Bunch celebrates its sixth birthday in 2006. This revised playbook reflects the lessons learned during that period by Wild Bunch coaches on three continents operating at every level from coaching 8-year-olds to semi-professionals.

The biggest change so far in the offense has been the addition in 2004 of the Rocket Sweep series (pp. 62-72). A public high school in Chicago and a semi-pro team in New Jersey both reached their championship game using the new Rocket-fueled Wild Bunch. A youth team in Utah won its state championship running the offense practically verbatim from the playbook.

A number of coaches have requested video resources on the Wild Bunch, and I am happy to say a DVD project is taking shape which will feature not only game footage but extensive whiteboard analysis of the offense, as well as information on its installation. Coaches are, as always, welcome to contact me at seayee@hotmail.com with any Wild Bunch-related questions.

CHAPTER 1: WHY RUN THE WILD BUNCH?

We may not know more about football than most of the other coaches in the league, but we can put everything that we know together so that it makes good basic sense, and then drill, drill, drill it into them.

-- Vince Lombardi

Like many other coaches, the trials and frustrations I have known during years of coaching football have led me in search of the "good basic sense" that the immortal Coach Lombardi referred to above. (I will expand on the "drill, drill, drill" theme in Chapter 9 -- page 132). My personal coaching odyssey began with the Wing-T as a high school lineman. The complex interplay of all four backs and seven linemen which characterizes the Nelson/Evashevski/Raymond/Kempski offense made a deep and lasting impression on me, to which I will refer a number of times in this work. (Indeed, a colleague pointed out in 2001 that the Wild Bunch formation is basically an "exploded" version of the well-known Red/Blue Wing-T formation variants.)

The quest that we all undertake is to find an attack that gives us a fighting chance against even superior opposition. If all of us were blessed with the talent that the University of Miami seems to attract every year (not that they don't work very hard to achieve their success), we could probably line up any way we wanted to and do what we liked on offense. Sadly, that first day of practice seems to roll around every year with no Supermen in sight. If you're lucky, you have one or two superior linemen and the rest smaller but athletic "tryers"; if you're unlucky, you're loaded with what a colleague calls "Dorito™-eaters" who only show hustle and killer instinct when the Pizza Hut™ delivery boy is at the door. Similarly, your backfield and receivers never seem to threaten any school records, except possibly Slowest and Most Malnourished.

For this reason, we are all always in search of that Holy Grail of football, the "equalizer" offense. At one point, I thought a combination of the triple option running game and the Run and Shoot passing attack was the answer. The reasons for adopting the R&S were simple -- I was aware of the amazing offensive records that were being set with it, and it provided the kind of simple logical progression that appeals to me.

"The Run and Shoot wants to overload and outflank zone coverages, while creating individual mismatches and forcing [man] defenders to lose leverage."

(Al Black, Coaching Run-and-Shoot Football, Harding Press: Haworth, NJ, 1991.)

This meant defenses could be attacked no matter what they did: If they rolled to strength when we motioned to Trips, they left 1-on-1 coverage

on our backside receiver, which we could exploit; if they chose not to, they faced a distinct numbers disadvantage to strength; while if they weakened their front to help Trips under-coverage, they invited the run. Meanwhile, they were forced to play "assignment" football facing the Triple Option.

This Spread Option Run and Shoot (SORS) offense was powerful and fairly simple to teach (although the Triple Option took up an amazing amount of practice time), but I still wasn't where I wanted to be -- it bothered me that I needed to use one kind of motion to create Trips receivers, and another to run the Triple Option. I was looking for a ground game that would seamlessly complement the Run and Shoot passing attack. (Those interested in a copy of my SORS playbook will find my e-mail address at the bottom of page 3.)

My next step, however, was to add the Bunch to the R&S. As I explained in the first edition of this playbook, I wanted to eat my cake and have it too -- to spread the field and throw R&S passes, and also compress it and throw Bunch pass route packages. The result was the Wild Bunch formation (page 6).

The Bunch Attack intrigued me because of the possibilities it promised for taking the passing game in directions the R&S alone could not. As Coaches Andrew Coverdale and Dan Robinson have pointed out, the Bunch Attack uses severely tightened receiver splits to: Create space on outside routes; attack the backside of the formation quickly versus defensive overloads toward the Bunch; create separation vs. man defenders through natural rubs; and attack zones by flood and trail mechanisms, while also delaying pattern reads through the close proximity of Bunched receivers. (The Bunch Attack: Using Compressed Formations in the Passing Game, Coaches Choice Books: Champaign, IL, 1997.)

The Wild Bunch running game at first consisted solely of the R&S Trap and Draw combined with the Inside Zone, Outside Zone/Stretch, and Counter Gap plays. It was not a perfect solution, but it allowed me to start building the offense in a way that held together as a systematic whole, not just a collection of plays to be grab-bagged on game day. I quickly grew frustrated with the Stretch play as a mechanism for getting outside defenses on a consistent basis, however -- especially since I believe in playing a larger, stronger, often slower type of back at the F (fullback) position for his blocking and inside running abilities.

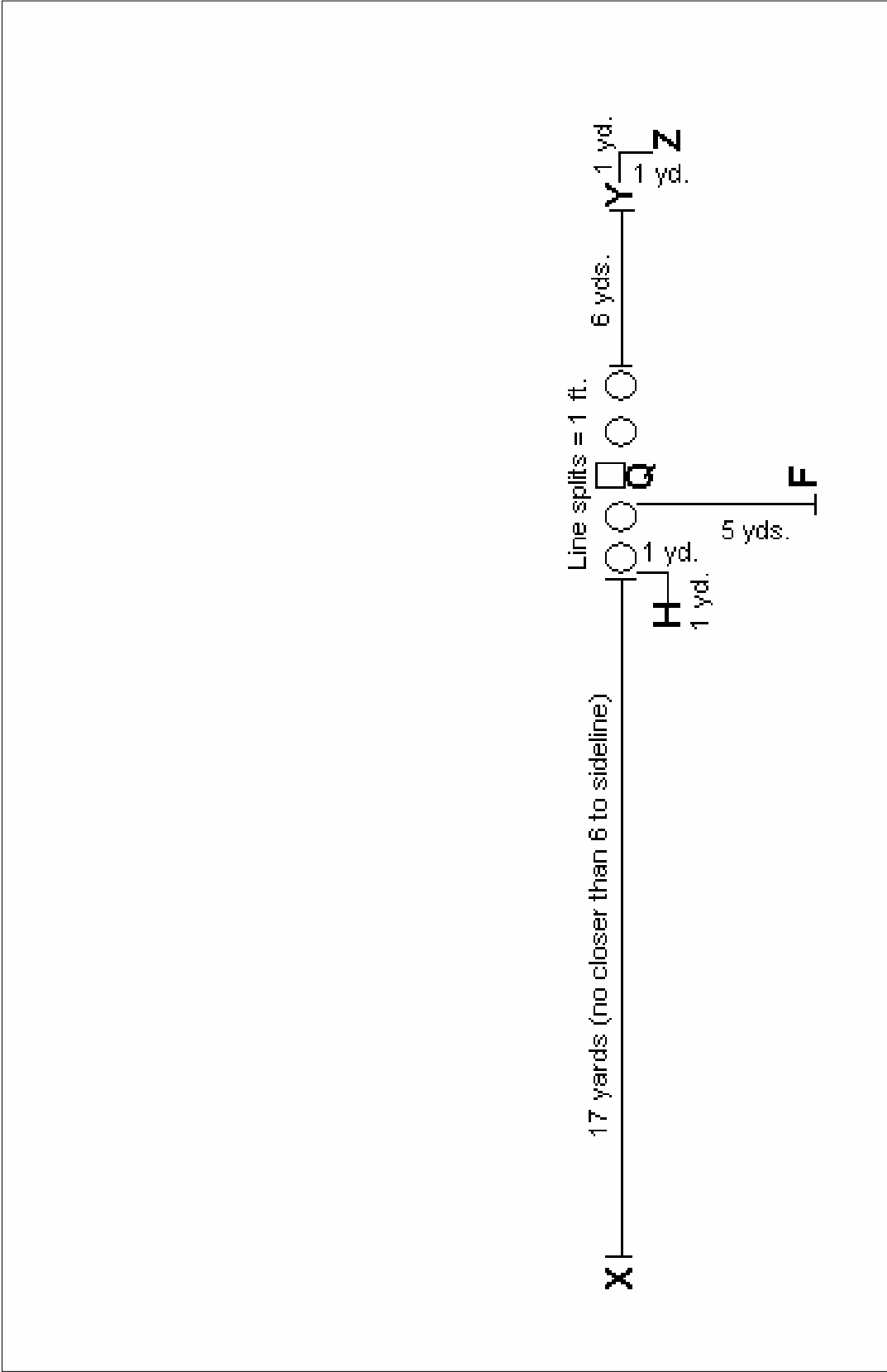

Wild Bunch -- Right Formation

The next piece of the puzzle snapped into place when I learned about the Fly Sweep series in the late 90's. I believe the Fly is one of the biggest offensive innovations in years, and I think that statement will be borne out over the next few years at the high school and college levels. It involves speedy wide receivers in the outside running game; it maintains the threat of the quick inside burst by the F back; and it threatens bootleg action away from the sweep on almost every play (or else it drops the QB back quickly -- after faking to two different backs -- to throw some of the best play-action passes I have seen).

As Coach Mark Speckman of Willamette University in Oregon has noted, the Fly sweep series: Is not lineman-intensive (it seeks OL vs. LB matchups whenever possible); not precision-dependent, but very forgiving (which Coach Speckman contrasts directly with the Triple Option); and revives the lost art of deception in offensive football.

"Anyone can be an All-American faker...even dead guys can fake."

Coach Speckman adds that offenses that want to run the A gap must first open a crease. The D gap, on the other hand, is already there and yards wide, but takes time to get to. (Mark Speckman, Coaching the Fly Offense, Coaches Choice Videos: Champaign, IL, 1999.) His solution to this dilemma, the Fly Sweep, is a high-speed, modern version of Buck Sweep that requires an instant commitment by defenders, and which leaves them instantly vulnerable to the other plays in the series. I believe the Fly gains the advantages of option football for the offense, but without risking the QB on every play. It also provides a multi-focal, FAST run threat that spread shotgun attacks lack. Or as Coach Bruce Eien has stated, the motto of the Fly sweep series is "Sweep 'til they weep."

Finally, why did I not join the spread shotgun tidal wave that is sweeping the country? Simply put, my Wing-T roots rebelled. I will not abandon the quick trap to the F back lined up behind the QB, nor will I give up the pivoting, deceptive QB under center without a big fight. For another thing, the modern spread shotgun running game has never impressed me. It seems to have devolved into a "Draw and Dart" attack in many cases, with a leavening of option -- to which I have already discussed my objections. This is not to say that I am not a great fan of and believer in direct-snap offenses -- it's just that, if I were blessed with a Michael Vick at QB, I would want to give him more weapons than Dart and Draw to work with. (Once again, readers interested in learning more about my Modern TCU Spread offense, which also combines Run and Shoot, Bunch Attack, and Fly principles, will find my e-mail at the bottom of page 3.)

To return briefly to the formation itself, what are its distinguishing characteristics? I believe there are three worth mentioning:

First, the location of the X end places a horizontal stretch on defenses. Combined with the flexed deployment of Y and Z, the Wild Bunch is only

10 yards narrower than the Run and Shoot's Spread formation at its widest -- but I believe the power of the Bunch more than makes up for this "deficiency".

Second, the flexed Y end and Z back combination is an unusual one for defenses and requires an adjustment of some sort. If defenses refuse to bring their Sam backer out to cover the Y end, for example, we have both an excellent blocking angle for wide plays like 11 Sweep (p. 50) and a free release for one or both receivers, which we can easily exploit by game plan or by audible, with our 56 Screen (p. 96, and see our automatic system explained on page 19). If they do send Sam out to help cover the Y/Z combination (and, after H motions across the formation to within a yard of Y, the full three-man Bunch), he is playing out of position and being asked to do things he's probably not very comfortable doing -- including dropping back and outside at a sharp angle to cover the quick passes to the flats that we like to throw. He becomes a fish out of water.

Third, I believe there are distinct advantages to running a "1.5-back" offense with F behind the QB and H flanked as a tight slot just outside the Spread Tackle. From his strategic position, H can: Take the Fly Sweep hand-off or Rocket Sweep toss from the QB running at close to full speed; block on the edge for Z running the Fly or Rocket Sweep the other way, or for other running or passing plays; release quickly into pass routes, whether vertically, across the formation, or out into the Spread-side flat; counter quickly against the grain on a "scissors"-type play (23 Tackle Trap, p. 68); or lead block on 34 Counter (p. 77).

The final reason to run the Wild Bunch is what I call the "unity of apparent intent". We make plays look as much like each other as possible before the snap and for as long as possible after the snap as well. Sending a receiver in motion across the formation gives the defense little or no useful information about our intentions until it's too late. To buttress this, we insist the QB take the same read of the defense before every play. He scans from right to left looking at the defensive front, then from left to right looking for the coverage. If he sees anything unusual, this scan will cue him to audible to a different play if he thinks he can improve on our call from the sideline.

Another "unity of apparent intent" aspect ties back into Coach Lombardi's "good basic sense" theme. The Fly Sweep series blends together the two passing attacks (Bunch Attack and Run and Shoot) through the use of identical motion no matter what series we are running; this in turn delays defensive recognition, sets up its own play action, and tends to make run defenders relax once the motion back has passed behind the QB -- which in turn opens up the inside running game to the F back (and the outside with 1X Crash -- page 56).

The Rocket Sweep series (p. 62), in turn, may be the single most promising "equalizer" series in modern football -- it really does appear to

make slower running backs functionally faster. I believe the Rocket and its complement offer coaches a great synthesis of speed, power, and misdirection. I wish to thank Coach Chuck Klausing of Indiana, Pennsylvania (and the NCAA Hall of Fame) for his enthusiastic help in educating me about this exciting new offensive trend.

This does not mean I am abandoning the Fly Sweep series, however. Among other things, the Rocket series sacrifices the use of identical motion with the Bunch and Run and Shoot pass plays. Rather, I am presenting all of these ideas in a more modular, series-style layout than in the first edition, and hoping readers will be able to pick and choose what works best for them.

When all is said and done, I still expect a coach to be able to look at his personnel before the start of the season and choose around 30-40 Wild Bunch plays from the series that follow (Chapter 8, p. 47) that will best harness the skills and abilities on his squad. Time will tell whether I have succeeded. (Of course, he will probably only need 15-20 of those plays against any given opponent.)

Chapter 2, which is new to this version of the playbook and installation guide, explains how the "unity of apparent intent" theme applies to the entire offense, and shows how simplicity must be married to deception to produce success with the Wild Bunch.

Once you are familiar with the plays, please see Chapter 9 (p. 132) for a complete installation schedule and some tips on how to choose the plays that best suit your personnel; Chapter 10 (p. 139) for some suggestions on how to adapt the Wild Bunch to different game situations; and Chapter 11 (p. 146) for a full discussion of the philosophy behind the Wild Bunch. Be prepared, though -- I've stolen ideas along the way from Greek mythology, military strategy, strategic intelligence and warning theory, the code of the samurai, and operant conditioning. In the process, I have clarified my thinking on the meaning and uses of deception in offensive football, as well as on the calling of coaching football.

CHAPTER 2: THE TAO OF DECEPTION

Warfare is the Way (Tao) of deception.

Sun Tzu



Sun Tzu, Warrior-Philosopher

The first thing a new coach must grasp is the concept of limits. His resources are all limited: staff, budget, facilities, players, equipment, energy, and above all, time. This argues for simplicity as the only logical basis for planning a football program, and I believe this is a sound impulse. I also believe, however, that simplicity on its own can lead straight to failure on the football field. Simplicity makes your job easier, but it can also make the defensive coordinator's easier.

Chapter 11 (p. 146) outlines the process by which I sought to harness strategic thought as a coaching force multiplier. What I ended up with (and I suggest you read the chapter carefully when you come to it) was the crucial importance of deception, especially given limited resources. Whether it is ambiguity designed to baffle an opponent by presenting him with multiple-choice clues to your true intentions, or misdirection which seeks to trick the defense into chasing a player who isn't carrying the ball (or to cover with inside leverage a receiver who is about to break outside), the power of deception is critical to levelling the playing field against even the strongest opponent.

The application of this concept to the Wild Bunch is straightforward: as with many offenses, running plays will be grouped into series where every play bears a strong resemblance to the core running play. The concept has been extended in the Wild Bunch to the passing game,

however. Eleven of our plays resemble key core pass route packages at the snap, but with drastic variations in where receivers (and the ball) eventually wind up.

Deception is a powerful tool for coaches with limited resources, as Mark Speckman pointed out on page 7, and as Homer Smith notes:

“The best approach for inferior talent is the deception which any player can learn but which superior talent neglects.”

Yet I will state right now my belief that any offense which bases itself solely on its ability to deceive is doomed to ultimate failure. Sooner or later, you must be able to execute what you do best -- even when the other team expects it.

My theory is that simplicity and deception complement each other perfectly, giving underdog teams a fighting chance for success while not overwhelming limited resources with endless variations on misdirection maneuvers. To state things as plainly as possible, my philosophy for the Wild Bunch is this:

| |
|---|
| SIMPLICITY x DECEPTION = SUCCESS |
|---|

This is not an additive formula, you will notice -- I believe that deception, intelligently designed into the heart of an offense and practiced diligently, multiplies the value of all the time saved through simplicity; while simplicity multiplies the power of deceptive offensive design by focusing practice time on doing a relatively few things perfectly.

The Wild Bunch is accordingly built around a few series of running plays (the Fly Sweep or 10 series, the Rocket Sweep or 20 series, and to a lesser extent the Inside or 30 series) with play action passes and other deceptive plays branching off from each of a few core runs (Fly Sweep, Rocket Sweep, Belly Sweep, Quick Trap, Inside Zone). The passing game, meanwhile, revolves around a few powerful pass route packages (Run and Shoot Go, Air Raid Mesh, Bunch Mesh, 3/4 Verticals) divided conceptually among vertical stretches, horizontal stretches, and man-beater combinations. Within those classifications, there are several deceptive pass route packages (or else “tags” off of core route packages) which strongly resemble the core package at the snap and for the crucial split-seconds thereafter.

(As an example, see 74 Mesh, p. 110, and its “evil twins,” 70 Arrow and 75 Shallow, pp. 106 and 112. These concepts can all be run from 74 Mesh with appropriate receiver tags, but we use these three so often -- as Coach Chris Brown notes, they form an unholy Trinity of passing power by showing defenders the same look for several steps -- that each merits its own play number.)

CHAPTER 3: CHOOSING PERSONNEL



Fu Zi Bo ("Football")

The Wild Bunch is not a highly personnel-intensive attack, in my opinion. It does require certain qualities at some positions, but I believe teams can succeed with this offense with quite a wide range of personnel types. The qualities I am looking for are detailed below by position.

X end: This is the primary receiver in an offense that features a lot of throwing. He must have great hands and "football speed" -- blazing speed is welcome, of course, but what matters is the ability to separate from defenders. We ask X to do a fair bit of blocking on the edge, but as often as not this involves releasing for a pass to soften the corner for a wide running play, then breaking down and screening the defender from the ball when he reacts to the run.

Z back: Speed kills. This should be the fastest man on your team who can catch a football. We believe we can teach fast people how to run the Fly and Rocket Sweeps well, but we can't teach good runners speed. Like X, Z must be able to block downfield.

H back: Ideally, we want a halfback type who can catch the ball as well as Z, run even better with it, and who combines the qualities of speed, quickness, and toughness. As noted in Chapter 1, the H back must be versatile enough to run, catch and block under a variety of circumstances. A Roger Craig would fill the bill perfectly.

F back: We want to fill this position with a real tank -- a prototypical fullback. Blocking is first, inside running is a close second, and limited pass receiving is a fairly distant third. If you have a spare Guard who can carry the ball with great forward lean, you just might have yourself an F back.

Y end: This is a fairly unique position, and ideally calls for a combination TE/SE -- someone with a bit of height who can catch, block downfield, and when necessary pass block an edge rusher. Great speed is not essential, but toughness and quickness are. The Y end runs more than his share of crossing routes, and will crack block on LB's on a regular basis.

QB: I am a great believer in putting smart kids at QB, especially in this offense. Not an Einstein, but someone who picks up new concepts quickly -- I need a QB who "gets it". Arm strength and foot speed may vary, but his mind must be sharp. Leadership is a big plus at this situation, although in my experience a lot of kids grow into that role as they come to understand that they control the success or failure of this offense through their actions. That doesn't mean we need a Unitas or Montana under center; but it does mean we are looking for a sharp, decisive mind and a lot of resilience to go with it.

Offensive line: I save the best for last. At the high school level, if I get one superior lineman at the beginning of the year, I will put him at Center. Why? Because he may be called upon to pass block a nose man by himself, and I want someone who will keep the pocket from collapsing when he's one-on-one with a stud DL. I put speed and agility at the Guard positions, since they do a lot of pulling and trapping. If I have size at both Tackle spots, I'm happy. If they can redirect edge rushers away from our QB's launching point, and run their tracks to the second level on the Fly or Rocket Sweep, I'm very happy. If you have a big, immobile kid, try him at Bunch Tackle -- I think he will get more opportunities to grow by learning there, and there will be fewer opportunities for plays to fail just because he's not a better athlete. At the college or semi-pro level, I would be tempted to play one great lineman at Spread Tackle to keep speed rushers off the QB's back while he's throwing the Bunch (70 and 80 series) routes.

CHAPTER 4: SYSTEM BASICS - FORMATION, NUMBERING AND MORE

THE FORMATION AND ITS VARIANTS

I believe in using one formation, but over time we have developed some situational variations. They are diagrammed below.

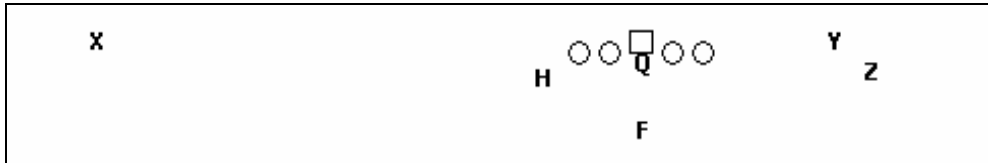

Wild Bunch Right (no formation call -- just "Right")

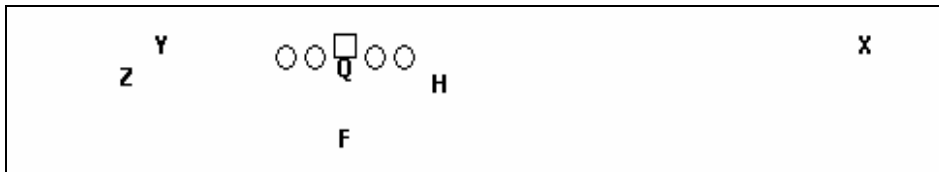

Wild Bunch Left (no formation call -- just "Left")

This is how we normally deploy. "Right" and "Left" are always determined by the location of the Bunch side of the formation -- and that depends on where Z lines up (see below). The linemen on the Bunch side are referred to as Bunch Guard (BG) and Bunch Tackle (BT); those on the Spread side of the formation, as Spread Guard (SG) and Spread Tackle (ST).

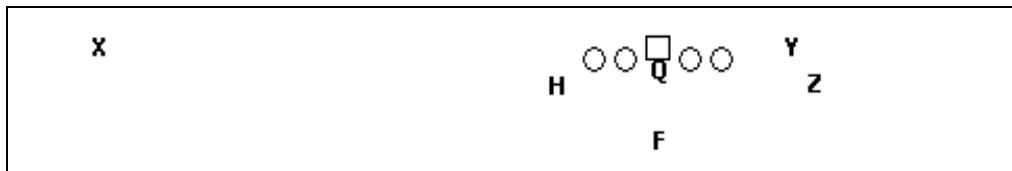

SNUG Right

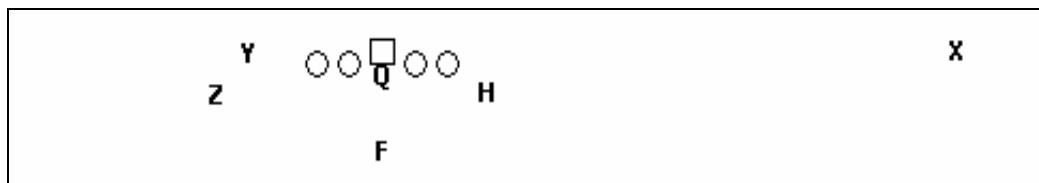

SNUG Left

The SNUG variation brings both Y and Z within 1.5-3 yards of the Bunch Tackle (based on your age group and/or game planning). I recommend SNUG as the base set for youth teams running the Wild Bunch.

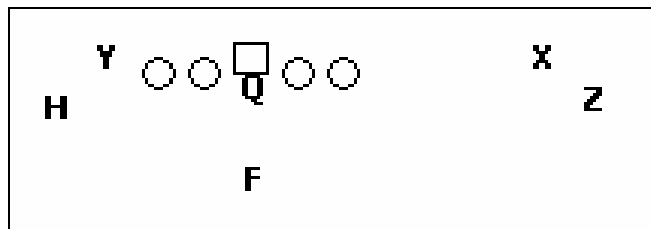

SWAP Right

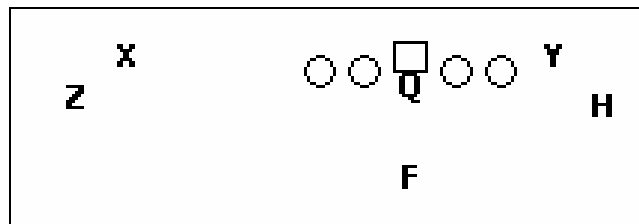

SWAP Left

SWAP brings X over to the Bunch side of the formation to "swap" with Y, who now lines up tight on the Spread side (a yard outside ST), with H lining up a yard outside him. Everything else is identical to the Wild Bunch formation. We use this formation as part of our MAX protection scheme (page 31).

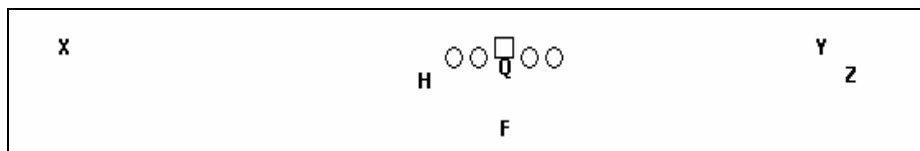

SPREAD Right

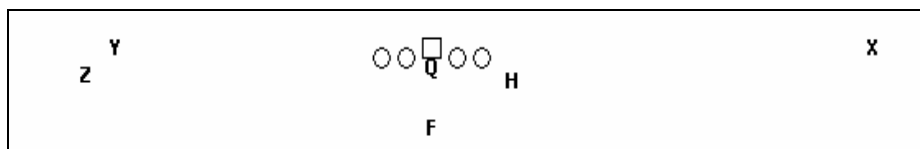

SPREAD Left

SPREAD is my version of Coverdale and Robinson's "CLUSTER" alignment for the Bunch (the normal Wild Bunch corresponds to their "SQUEEZE" alignment). Y is now 14 yards from BT, or eight yards further than normal. Z retains his 1 by 1 yard alignment on Y, and the formation is otherwise identical to the Wild Bunch formation.

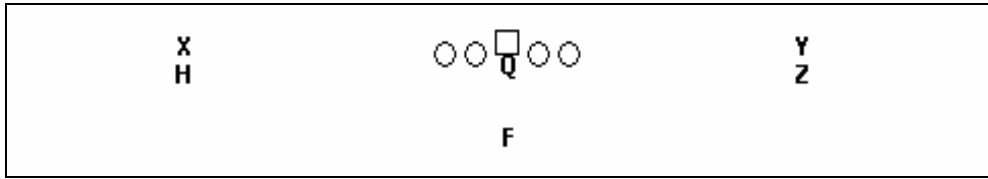

STACK

STACK is an attempt to take advantage of some very interesting double- and triple-stack route packages (which appear here as part of our 80 series, pp. 118-122). We do not mirror it right and left because it is symmetrical, so we always line up with the Bunch personnel to the right. Both X and Y are split about 10 yards from their tackles.

From STACK, we can mirror double-stack routes on each side of the formation and pre-read the coverage to choose the better percentage side; or we can use the Coverdale/Robinson "packaged sides" concept, with different double-stack routes on each side to attack different types of coverage, then choose which side to throw to based on the coverage that develops after the snap; or we can motion to a triple stack (3STACK) and throw isolation routes to the backside receiver (e.g., the R&S Choice concept).

NUMBERING AND PLAY-CALLING

The diagrams below show how we number our holes for running plays. The important thing to remember is that the holes flop along with the players as they shift from Right to Left formation and back again. The 3 hole, for example, is always over the Bunch Tackle.

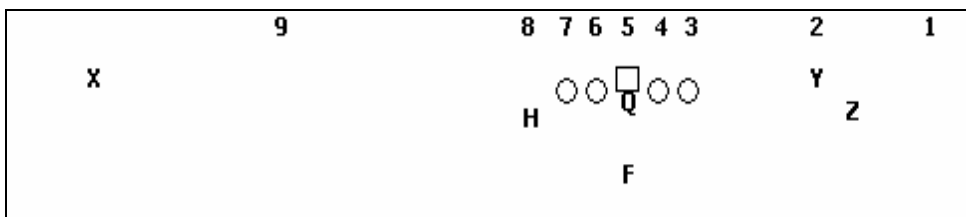

Hole numbers from Right formation

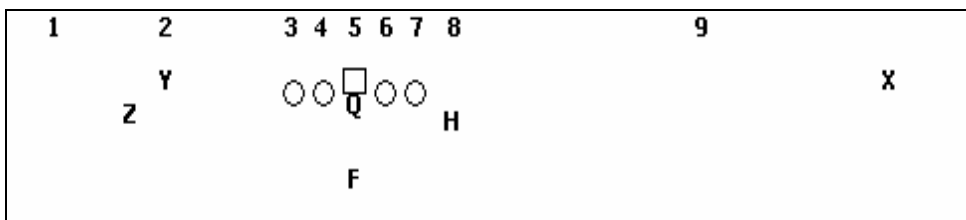

Hole numbers from Left formation

In the original Wild Bunch playbook, I used the numbering system I have used for many years -- runs were two digits (back number followed by hole number), while passes were designated by three digits -- blocking scheme, motion (if any) and pass route package number. Since adding the Rocket Sweep series to the Wild Bunch, however, I have gone with an even older numbering scheme, that of play series. Now all my plays are designated by a two-digit number -- the first digit indicates basic information about the core or base play of the series (10 Series is Fly Sweep; 20 is Rocket Sweep; 30 is Inside series; 50 is No Motion passing; 60 is Motion to Spread; 70 is Motion to Bunch; 80 is STACK and MAX; and 90 is Specials), while the second digit is usually either the hole number for running plays or the pass route package number for our dropback and sprint passes. Play-action passes have been fitted into the 10-30 series, and pass-action runs and screens into the 50-80 series, however, pretty much wherever there were spare numbers available. This means the new system is somewhat less informative than the old numbering scheme, and requires slightly more memorization. However, I still recommend no more than about 20-25 plays as a standard load for a Wild Bunch offense, and that really isn't much to ask by way of memorization. In addition, it also simplifies the task of audibles greatly -- now we can just use play numbers themselves as part of the audible (p. 19).

THE HUDDLE

Our huddle is functional. It allows for the team to quickly form together to hear a play call from the QB. The Center lines up five yards from the ball with his back to it. The Spread Guard and Tackle line up to the right of the Center, with the Bunch Guard and Tackle on the left. They stand, relaxed but attentive, facing their own goal line. The front row stands right in front of the line with their hands on their knees but their heads up, also facing straight ahead. No one except the QB speaks in the huddle unless given specific permission by the coaching staff. The huddle is diagrammed below.

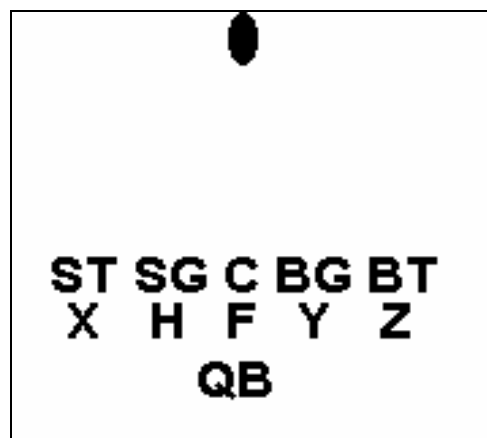

Wild Bunch Huddle

The quarterback will call the formation, play and snap count, repeating the call twice, before breaking the huddle with a loud, crisp "BREAK" and handclap by the team. (Example: "Right, 74 Mesh on second GO; Right, 74 Mesh on second GO. Ready, BREAK!!" [CLAP!]) The line will turn and assume their positions over the ball based on the formation call -- Right or Left. We have used both a two-point pre-stance for our line and a normal three-point, depending on whether we want to be able to snap the ball and only throw passes on "SET" (see cadence section below), or whether we want to be able to run a full complement of plays on a quick count. Other years, we just forgo the whole question and have the line set in three-point stances as soon as they reach the LOS.

NO-HUDDLE

We can also run without a huddle. The easiest way to do this is through the use of wrist coaches that contain a matrix of our play numbers along with vertical and horizontal coordinates. You can either write or signal the coordinates in from the sideline -- if you are worried about getting signals stolen, either write multiple numbers on the whiteboard (making sure your players know which one is "live" at any given time), or have multiple people signal in the numbers. If the cost of wrist coaches is prohibitive, you can just use the whiteboard or wig-wag methods to send in the actual play number. I find the easiest way to indicate formation and snap count is by game plan -- i.e., we will always set the Spread side of the formation to the field this week, and all passing plays that involve motion will be on second "GO", for example.

Running no huddle gives two advantages in games. It allows for true "warp speed" offense, where many more plays can be run in the same amount of clock time. It also permits the exact opposite -- that is, to slow things down by burning off all but 5 seconds on the play clock while in position at the LOS, which tends to make defenses very impatient -- and thus more mistake-prone. No-huddle practice also has two advantages -- many more reps in the same amount of practice time, and a better-conditioned team without wasting time running sprints.

CADENCE

I believe in using a non-rhythmic snap count, especially since we need to be able to coordinate the timing of the snap and the location of a man in motion. The snap count I have always used is "SET...READY...GO...GO...GO." The ball can be snapped on "SET" without motion (i.e., quick count). The motion starts on the word "READY", which the QB can stretch out to coordinate the timing of the motion and the play. Finally, we can snap the ball on first, second, or third "GO". The team will come up to the line of scrimmage and set itself for a full second before the QB starts the cadence. The QB scans the defense from right to left, looking at the front, then from left to right, locating and pre-identifying the coverage. He then calls a series of numbers, which allows us to run audibles.

AUDIBLES

We use a very basic audible system at the line of scrimmage. The QB will call out a color, followed by a two-digit number (which is a play number), once to each side of our formation; he will then pause for a second before starting our cadence. (Example: "Red-Sixteen! Red-Sixteen! (Pause) SET! REA-DY! GO!!")

The only time an audible is "live" and will replace the play called in the huddle or from the sideline is when the color is the one we have designated as "live" for that game (or even, in some cases, that half). All audibles are always run on first Go.

We start teaching automatics from the very first day of practice. There is no requirement that we use our actual play numbers as automatic numbers, by the way -- but it is one more way to make learning a bit easier.

MOTION

The Wild Bunch allows multiple levels of deception. One of the most useful is to simulate passing by sending a receiver wide in motion (notably Z to the Spread side of the formation as with our 60 series), then snapping the ball and handing to the F back up the middle. The easiest way to use this powerful tool is to add a two-digit motion indicator to the play number. For example, "35-60" would indicate that 35 Quick Trap (p. 73) was to be run with "60 series" motion; that is, by sending Z in motion toward X on "Ready". The alternative would be to call "35-70", which would send H in motion to form the Bunch with Y and Z.

Adding this simple two-digit number to certain play calls will allow you to increase your deception at absolutely no extra teaching cost to your players. Some of the best combinations are:

35-60 or 35-70
34-60
36-60
38-60

(In each case of "60" motion, Z should be out near X when the ball is snapped, as with "60 Short" -- p. 98.)

SHIFTS

The only shift I sometimes use is the "Scatter" concept. I call "Scatter to Spread Left" in the huddle, and X, Y, Z and H will line up wherever they feel like. On a command from the QB, they will then shift to the formation called in the huddle. This is an easy way to confuse defenses.

CHAPTER 5: FORGING THE LINE



We try to make playing offensive line in the Wild Bunch as simple as possible. Our running plays use one of three different blocking philosophies: Zone, Trap, or Gap. Once we teach the basics of these philosophies, we believe our linemen can adapt them to game conditions with very little extra teaching. There are always exceptions, of course - - defensive coordinators are nothing if not endlessly inventive. For this reason, we also use three line calls, detailed on pp. 22-23. Finally, as noted previously, we have three kinds of pass protection, which we call SLIDE (dropback), SPRINT (roll-out and semi-roll), and FAKE (play-action) passes. In other words, if you can count to three, you can play offensive line for me.

Stances are balanced in the Wild Bunch, since we ask our O-line to move in any direction with equal facility -- forward to fire out, back to pass protect, and sideways to pull, zone or cut off. We allow a slight stagger between the feet, but we want them no wider than shoulder width and able to move to either side with equal ease -- if they can't do that, their stagger is too great.

Our line splits are one foot, which can always be measured with an actual foot (most linemen have big feet, so this tends to work in almost every case). These tight splits make pass protection easier and enhance our outside running game by bunching the defense in tight. While it might seem that they should hurt our inside running game, we will not run inside unless and until the defense has spread out to combat our wide attack.

One final note: The diagrams in this playbook may not always indicate it, but our Guards and Tackles line up with their helmets even with the waist of the Center -- that is, off the ball as far as the rules permit. We find this helps both our zone run blocking and our pass protection by giving our linemen more time to lock onto their targets.

RUN BLOCKING

Zone: The best description I have ever heard of how to acquire your target when zone blocking comes from Coach Jerry Campbell: "Find the nearest defensive ear and stick your helmet there." It just doesn't get much better than that.

Offensive linemen who have a DL on them will block him, possibly with the assistance of another OL. The rule they follow when uncovered is to step toward the POA, either to double-team or through to the second level. The only possible exception to this is if they are the lineman over whom the play is called. If we are running 36 Zone (p. 75), and there are DL's over both the Center and Spread Tackle, the Spread Guard might not know which way to block. We solve this by telling him that if he is at the POA, and two DL's are equidistant from him (so Coach Campbell's "nearest defensive ear" rule is no help), he should block out on the Spread Tackle's man. Since we are blocking toward the POA on the backside, and the QB is responsible for bootlegging to hold the backside EMLOS defender, SG can't go too badly wrong blocking to his outside.

The secret to zone blocking, I believe, does not lie in mastering special "bucket steps" or other fancy footwork. Rather, it consists of attacking defensive linemen with two aggressive blocks while looking through to the second level for the nearest linebacker. That said, we do teach different techniques for covered and uncovered linemen: covered, they will step to the outside earhole of the defender over them; uncovered, they will step laterally to protect their playside gap, then downfield on a track that will pick up either an inside stunt by a lineman or a scraping linebacker.

If two offensive linemen can create vertical movement on the DL they are zone double-teaming, the play has a chance to make yards. The "four hands on the DL, four eyes on the LB" formula has proven successful for many teams in recent years. If the DL takes a side, the OL on that side will maintain leverage on him while the other slides off to the second level. If, on the other hand, the DL attempts to split the double team block, the OL's will push him straight back into the LB. This is something we get hundreds of reps on during pre-season practice. There is simply no substitute for repetition when it comes to practicing zone blocking.

Trap: The quick trap to the F back is periodically written off by defensive theorists as obsolete. Indeed, there are defensive fronts that are extremely difficult to trap in the traditional manner. If a defense ever combines such a front with coverage schemes that can consistently shut down the Wild Bunch outside running and passing games, I will bow to the inevitable and drop the play from my repertoire.

Fortunately, that hasn't happened yet. When facing double eagle and other fronts that make trapping harder, we will concentrate on other

targets of opportunity. If we are successful and they stay in their front, we won't need to trap. If, on the other hand, their DC switches out of their compressed fronts to deal with those other threats, we have a great play waiting to hit them with right up the gut. Among other things, the quick fullback trap is one of the best draw-substitutes known when run with long motion across the formation. With the Run and Shoot (60 series) pass route packages in particular, there is something about motioning Z all the way out to the perimeter that gets interior defenders geared up to rush the passer -- and uniquely vulnerable to being trapped.

The basic rules for the quick trap hold up pretty well:

Center: G.O.D.: Backside Gap, man On, Down block (man over backside Guard).

Playside Guard: Gap/Down -- DL or LB in A gap, then man over Center.

Backside Guard: Pull and trap first color past Center.

Playside Tackle: PG covered, block on or out; otherwise, 1st LB inside.

Backside Tackle: Man on, 1st man playside (On/Up).

One key to running the play successfully is that, when facing a Miami or Slide 4-3 front (and all other things being equal), you want to trap the 3 technique tackle rather than the 1 technique -- the blocking angles are far superior. Facing the Wild Bunch, however, there is some doubt about which way Miami 4-3 teams will line up their fronts. Will they align the 3 technique to the Bunch side, even though the Y end is flexed out 6 yards, or will they set him to the Spread side because of the location of the H back? This is why I believe 35 Quick Trap (p. 73) must be taught in both directions, with either the Bunch Guard or the Spread Guard pulling. This can either be called in the huddle, or else communicated at the line by having the QB call an indicator that starts with the letter "B" (for Bunch) or "S" (for Spread) to tell which Guard to pull before he starts his normal cadence.

Gap: Our 34 Counter (p. 77) is obviously the Washington Redskins' immortal Counter Gap play, with Gap blocking principles used against all fronts we face. The play is run only to the Bunch side, so the rules are pretty basic:

Bunch Tackle: G.O.D.

Bunch Guard: G.O.D.

Center: G.O.D.

Spread Guard: Pull and trap first color past Bunch Tackle

Spread Tackle: Hinge (like Sprint backside pass pro)

The H back will normally pull through the first hole he finds on the LOS past the Center and look for the first wrong-colored jersey that shows. He should scan from inside to out as he pulls through the hole.

Line calls: We can call "Up", "Down", and "Pinch". Up has the whole line reaching playside, while Down does just the opposite. (This means

that we will have the whole line block in one direction whether the play is to be run inside or outside, although clearly it is more applicable to outside running play and pass blocking schemes. For this reason, we won't make any line calls for 35 Quick Trap.) Pinch brings everyone in toward the POA, and is also used to pick up inside blitzers (if called on a dropback pass, the line call should be "PINCH!" followed by the hole number where an inside blitz is expected -- "PINCH 4! PINCH 4!"). It is also an effective "point wedge" scheme when facing an unusual front with a running play called. The "Up" call can be particularly useful in half-roll (Sprint) protection, when the normal reach/hinge rule may not provide the best protection against a gap front. The Line blocks frontside gap, while the F back takes the playside EMLOS rusher.

I have had different linemen make the line calls at different times in my coaching career. I usually end up having the Center make the calls, although other linemen can direct the Center's attention to a potential problem -- by calling, for example, "Bear" (if they see a 46 look) or "Joker" (if they notice an edge rusher creeping up that the Center might not see) as the line sets, for example. The Center would follow up by calling "Joker Left" to warn the QB and F back.

PASS PROTECTION

First off, some thoughts in general about pass blocking. After initial work on stance and getting off on the snap, we try to emphasize three things in pass blocking: keeping the shoulders square for as long as possible; setting up to block relative to the QB's position; and communicating.

There comes a time when a lineman may have to turn his shoulders perpendicular to the LOS (to lock out a DE charging straight upfield and ride him deep, for example); but generally, the longer your guys keep their shoulders square, the better they will do.

Your linemen need to know their plays, so they understand where the QB is likely to be when he throws the ball. This will allow them to maintain what Coach Jerry Campbell calls the "half-man advantage" over the pass rushers they face. They want to skew their position half a man in the direction of the pocket to keep themselves between the pass rusher and the QB at all times. Leverage and positioning are more than half the battle when pass blocking.

Finally, communication. It is better for both the DL and OL to know who is planning to block whom than it is for neither group to know. We have line calls (p. 20), and they are very effective, but there may come a time when your kids just have to point at a defender and yell "I GOTTEM!"

To give credit where it is due, I have taken (that is, shamelessly stolen) my modified slide protection from Chris Brown's excellent "No-Huddle

Spread Offense" website: <http://www.nohuddle.freesevers.com/passprotection.html>

SLIDE Protection: All of our pass plays have a front side (the side of the play that the F back checks first for blocking responsibilities). Our pass protection starts on that front side with linemen blocking the man over them (from outside shoulder to inside gap) until we reach the first bubble -- the first lineman with no DL over him. From that point, the line slides to the backside to block the first DL back from them. The F back, meanwhile, will read from the LB in the bubble to the first LB outside the frontside tackle, if any. This may mean he has a double read, and must pick up the most dangerous and immediate threat; if so, the QB will be responsible for the unblocked defender.

To quote Mr. Brown:

"When sliding, the #1 rule is 'don't block air.' What this means is don't be in such a hurry to slide to your point that you expose a new gap or put your teammate in a bad position. We look at the slide as a flow, but the bottom line is we are still picking up defenders, not just flying to our respective A or B gaps. Again, the parallel shoulders are huge in sliding.

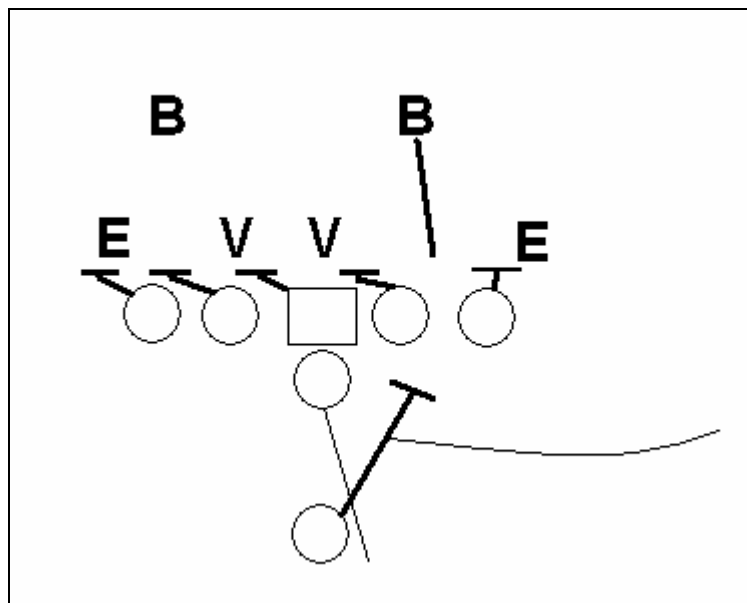

SLIDE (Drop Back) Pass Protection

"And finally, don't be afraid to be aggressive. In pass blocking you can't be too aggressive or you will get beat, but it does not mean you have to receive all the punishment. This is one reason we like the slide, is it seems like our line can do more punching and aggressive maneuvers and not be afraid of their man beating them. Particularly on 3-step, the OL should get their fists in the defender's chests/stomachs.

"For us the biggest weakness of the protection is the bane of most one-back protections: 4-weak. Also, second, are inside dog blitzes. You will also need to identify hot. The hot more than likely needs to come from

the slide side, but obviously the man side can be overloaded as well. We always build the hot routes in."

(Note: So do we, with our built-in "Q" routes.)

The following series of illustrations is intended to demonstrate how Slide protection works in the real world. You are facing a 3-3 Stack front, and from Left formation (with the Spread side to the right), you call 50 Seam.

The Spread Tackle, following his Slide rules, is responsible for the man on him (from his outside shoulder to his inside gap). There is a bubble over Spread Guard, though, so he starts the Slide by moving, with his shoulders parallel to the LOS, toward the Center to block the first DL inside him.

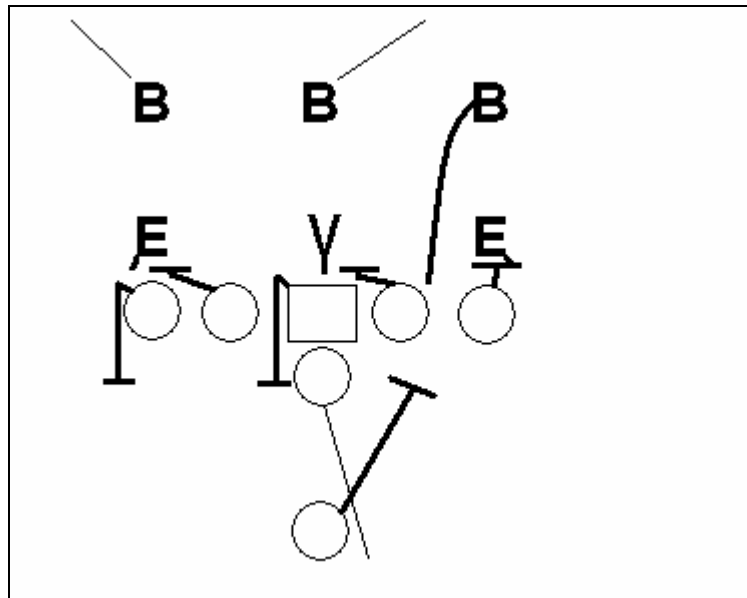

If a defender tries to blitz the gap inside him, the sliding Spread Guard will pick him up.

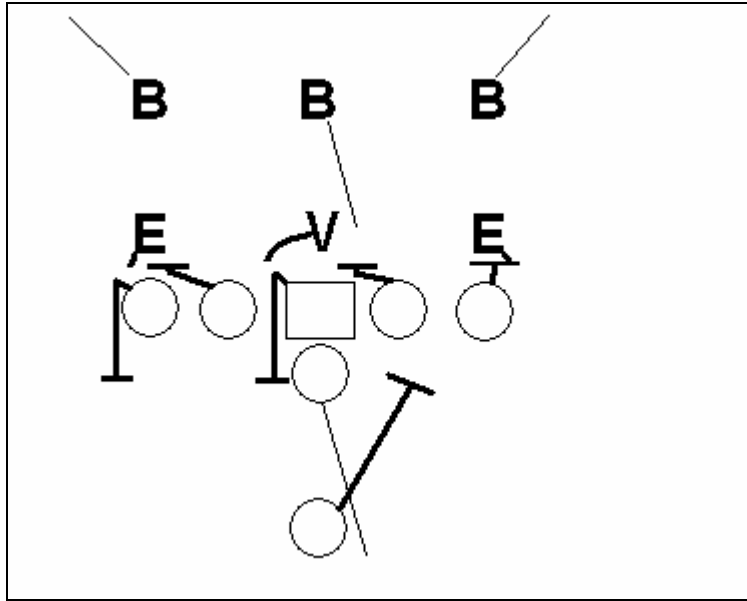

What about the first DL to his inside, whom we would normally expect Spread Guard to pick up in a Slide scheme? If he slants backside at the snap, the Center will pick him up (previous diagram), while if he loops playside, the F back should catch him when he checks the bubble for a blitz.

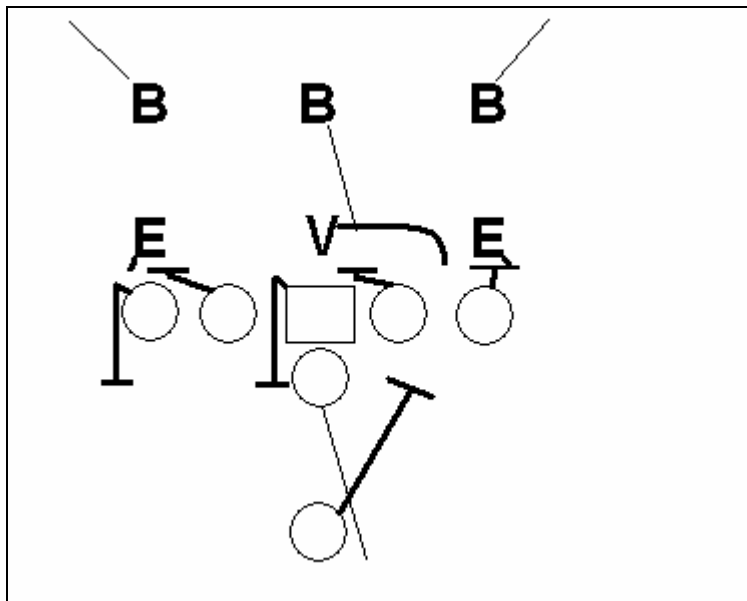

If the F back releases before the looping DL appears in the bubble, the QB still has a Q receiver -- the F back's Swing route -- to throw to and avoid the sack. In other words, either the protection holds up, or the QB has somewhere to go with the ball right away if it breaks down.

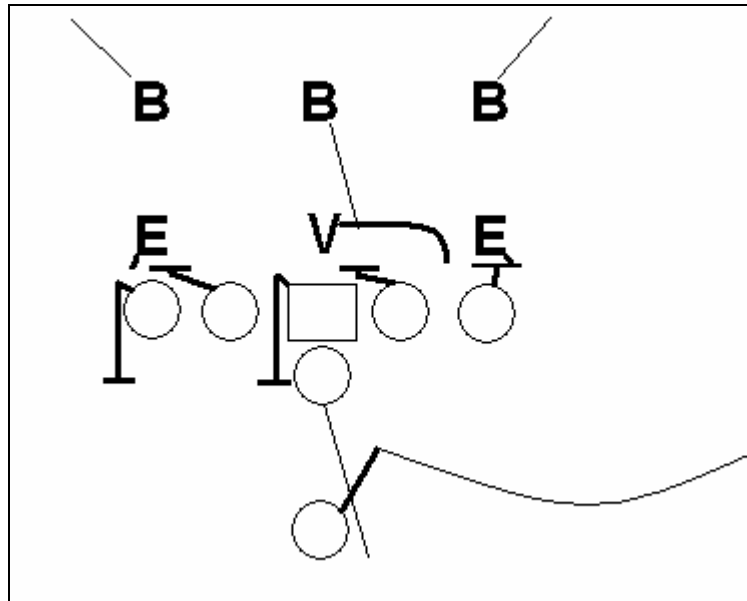

FAN Call: One other situation needs to be covered. If there is a defender outside the playside Tackle whom the Tackle believes is a rush threat, he can make a "Fan" call that will bring him and the playside Guard out on the first DL defenders to their outside (and here I include LB's and DB's walked up to blitz positions on or near the LOS). This can happen quite easily in a good old-fashioned 5-2 front (see diagram below).

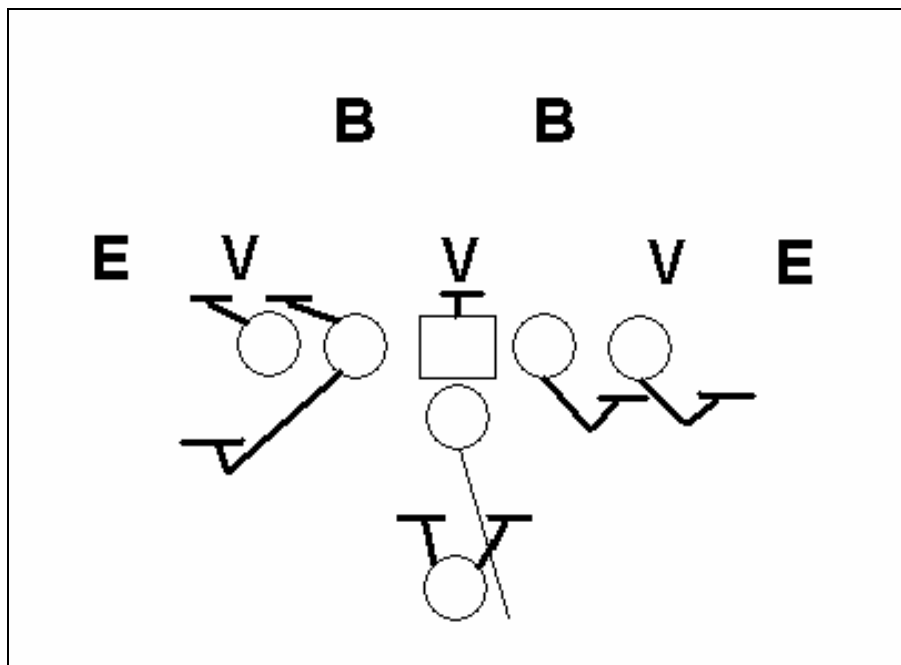

FAN Call

The playside Tackle (on the right) sees the overhanging defender and calls "Fan". This alerts the playside Guard to fan outside with his shoulders square to the LOS to pick up the first defender on the LOS to his outside; it keeps the Center home to block the 0 technique Nose

player; it tells the F back that he has an area read from the playside to the backside Guard, looking for the most dangerous rusher or helping the Center with the Nose man if needed; and finally, it tells the backside Guard that he will Slide as usual, but to listen for a "Fire" call from the F back, indicating that both ILB's are coming. If this happens, he will stay home and pick up his ILB while the F back takes the playside ILB. If there is no "Fire" call, the backside Guard is free to drop outside and pick up the backside EMLOS rusher if the backside ILB does not blitz.

The QB is responsible for getting the ball away quickly to his Q receiver if he hears the "Fire" call, because it means the outside rusher to the backside of the play is unblocked. The same thing can happen on the playside if the defense sends a fourth (or even fifth) rusher to the outside of the playside Tackle's block. There is no call for this situation, but the QB is responsible for getting the ball away quickly to his Q receiver if this happens.

This call points out the importance of having more than one type of protection for dropback passing situations. As much as I believe in the 6-man Slide protection scheme, I understand that I need not only a "Fan" call, but also to drill my QB's on finding their Q receivers quickly, AND I need 7- and even 8-man protection schemes to deal with specific situations. From the SWAP formation variant (p. 15), the 7-man protection is simply a matter of keeping Y in to block as part of an extended SLIDE scheme. The beauty of this approach is that, if the defender outside Y does not rush, he is free to check-release. From SWAP we can simply call "Seven", which tells Y to Slide protect.

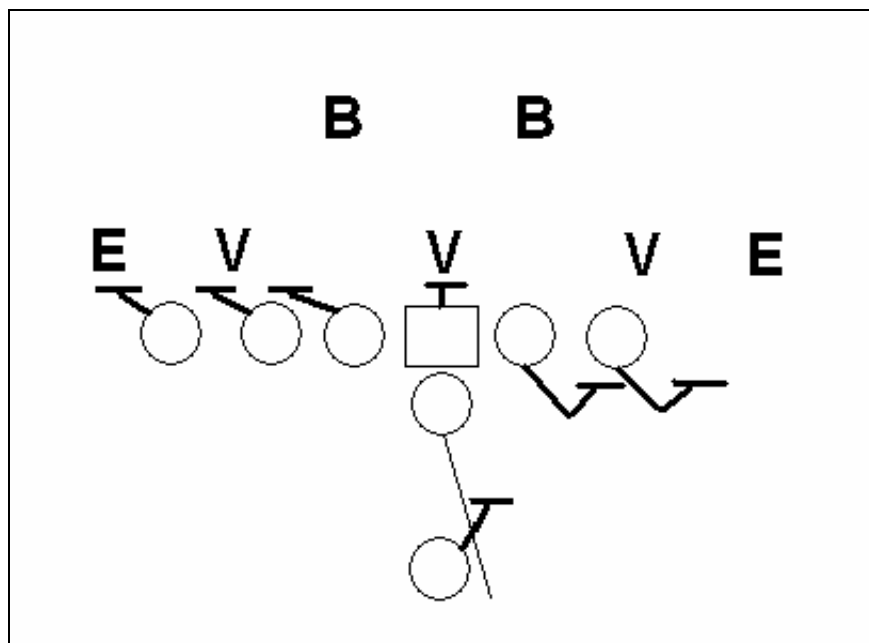

SEVEN call from SWAP

(See p. 31 for a discussion of 8-man MAX pass protection.)

SPRINT Protection: This is our mechanism for (deliberately) shifting the launch point for the football.

Backside Tackle: Hinge

Backside Guard: Hinge

Center: Even: Hinge; Odd: Reach (this includes a 1 tech shaded to playside)

FG: Reach

FT: Reach

Two important points: First, "Hinge" means the OL takes an immediate step to protect his inside gap -- not flat to the LOS, but back at a slight angle to give him a faster jump on gaining depth when he pivots and drop-steps on his second step, looking for the first rusher to his outside. The backside Tackle will drop further and faster than the backside Guard (and Center, against Even fronts). The second point is that "Reach" means that, if you cannot gain outside leverage on the DL you are trying to reach-block, you should lock him out and push him to the sideline. If you have a Reach assignment and are uncovered, step playside looking for stunting DL's or blitzing LB's; if none show, gain depth and help out backside. Protect your QB's back at all costs.

In SPRINT, the F back takes two steps toward the frontside sideline while reading the outside rush. If the EMLOS rusher takes an inside charge, the F back seals him inside and rides him past the QB. If he runs deep to contain, the F back locks out and takes him deep. If he attacks the F back hard and head on, the F back attacks the outside hip with his inside shoulder. If no one rushes, the F back checks middle and backside, then releases.

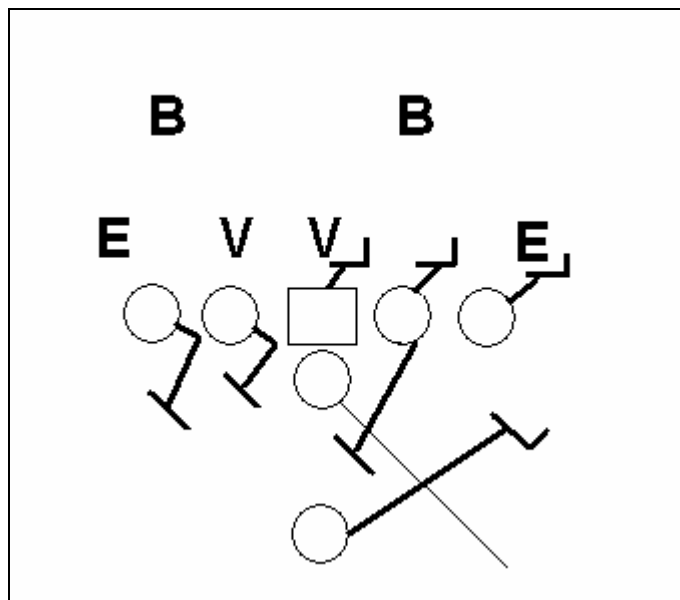

SPRINT (Roll-Out) Pass Protection

FAKE Protection: This depends, to some extent, on the running play being faked. We try to use our SLIDE principles as much as possible, but it is not always possible to match up the path of the running back with

the location of the defensive bubble. When such a disconnect occurs, we revert to basic BOB blocking -- Big On Big/Back on Backer. Our linemen will block the nearest DL rusher, while the F back will read LB threats based on the danger they present -- he may have to double-read against some fronts, and pick up the most dangerous rusher. If he sees both LB's coming, he knows the QB is busy with his play fake, so he yells out "FIRE! FIRE!" as he goes to block the most dangerous rusher, letting the QB know he must account for the other, unblocked rusher.

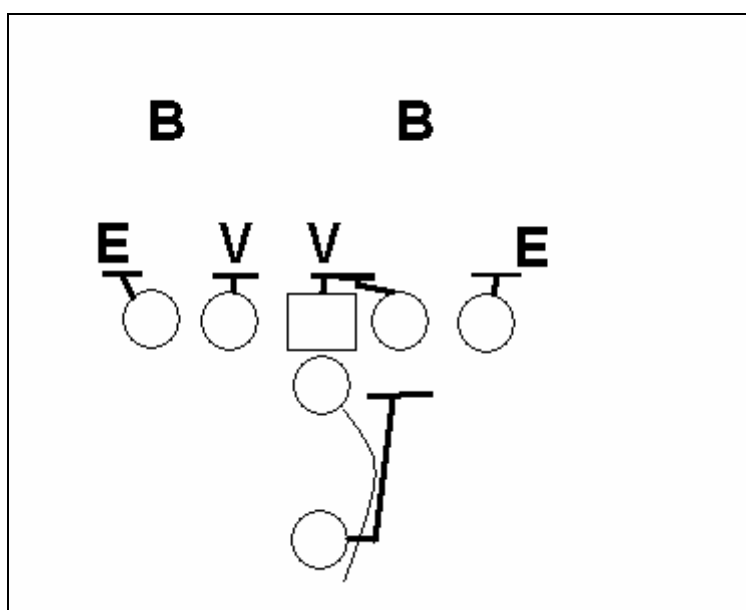

FAKE (Play Action) Pass Protection

I will also follow Chris Brown's example in quoting this excellent advice on play action passing from Bill Walsh:

"The offensive line can be an easy place for defenses to find indicators [that it is a play-action pass and not a run]. One of the easy reads for the defense is if a lineman's helmet pops up. The helmets and pads of offensive linemen have to stay at the same level as on a run play. The secondary defenders, corners or safeties, will see those helmets pop up or the tackle drop back and they know immediately that it is a pass. (For example, if the corner to the open side of the field is looking through an offensive tackle right to the quarterback and he sees that tackle's helmet pop up and step back-he will not care what the fake is, unless it is a fake draw -- he will automatically know that the play is a play-pass.)

"The quarterback must understand that play pass blocking is not as sound and can break down. He must be prepared for a pass rusher to get off of his blocker and be penetrating early. The quarterback must understand this, concentrate down field, and possibly take a hit just after he throws. [The Running back's] faking technique requires shoulders at waist-high level, arms and hands held exactly as in taking a hand off -- except the far hand is placed flat against the stomach so the ball can be inserted in the pocket then pulled out smoothly.

"Basic [play-action pass protection] requires the outside linemen (center-guard-tackle) to employ controlled, quick protection. This is taught as a technique. Contact is made at the line of scrimmage. The defenders cannot be given space. Any space between the defensive and offensive linemen indicates to the defense it's a pass. Contact should be sustained but in balance and in control, lunging forward can be disastrous. The ability to move laterally with the defender is critical."

MAX protection: Finally, we have a plan for blocking 8 rushers called MAX. It is designed to be run from Swap, and involves blocking the F back one way and the motioning H the other. We use pure BOB blocking in MAX. In the diagram below, the F back would double read the two ILB's, and call out "FIRE! FIRE!" if both blitzed.

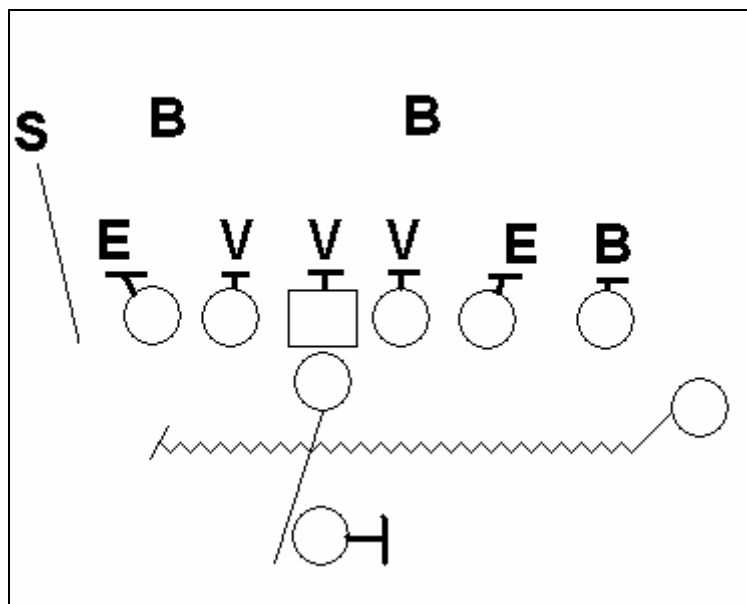

MAX Pass Protection

An important point about MAX protection, which I will explain when describing the special two-man pass route packages we run with this scheme (pp. 123-125), is that all three receivers who are blocking can check-release as soon as they are sure no rushers are free. The Y end and H and F backs can all release into delayed patterns as soon as it is safe to do so.

We obviously see a lot of stunts, blitzes and games from defenses, especially when we are in a passing situation. (See Chapter 10 -- pp. 145-146 -- for our thoughts on attacking the zone blitz.) We try to handle line stunts by area or zone blocking. When zoning a stunt, linemen must communicate. The diagram below shows the man over our Bunch Tackle rushing inside. BT goes with him, keeping him on the LOS. BG sees his man disappear behind BT and calls out "Loop". BG shuffles toward BT, bumping hips with him and contacting the inside rusher with his near hand. Both BG and BT call "Switch". BG now has the inside rusher, while BT squares up to meet the outside loop charge. We drill against this and other common line stunts every day.

CHAPTER 6: BACKS AND RECEIVERS



I will quickly outline the positioning of our potential pass receivers and running backs in the Wild Bunch.

The X end aligns 17 yards from the Spread Tackle, but never closer than 6 yards from the sideline (i.e., a yard from the bottom of the field numbers). He is in a two-point stance with his outside foot back and his hands up and ready to help him evade a press corner. If he is being jammed, he will use his escape techniques to evade the coverage. In Swap, X aligns 6 yards from the Bunch Tackle. In Stack he is 10 yards from the Spread Tackle.

The H back normally aligns a yard outside and a yard behind the Spread Tackle. He is in a three-point stance with his inside foot back so he can easily start in motion toward the QB. In Swap he aligns in the same 1x1 position outside the Y end, who is now outside the Spread Tackle. In Stack, he aligns directly behind X.

The F back aligns with his heels 5 yards from the LOS, directly behind the QB. He assumes a balanced three-point stance. This depth can be adjusted in certain special cases, such as a massive F back who is a step too slow to play at 5 yards depth -- he can be moved up to as close as 4 yards IF it will not interfere with the timing of any plays.

The Y end aligns 6 yards from the Bunch Tackle. He is usually in a three-point stance, but we do not insist he have his inside foot up. In Swap, Y lines up a yard outside the Spread Tackle. In Snug, he aligns 2-3 yards outside Bunch Tackle (or as little as 1.5 yards for youth teams). In Spread, he lines up 14 yards from the Bunch Tackle, or 8 yards wider than usual. In Stack, he is 10 yards from the Bunch Tackle. We give him the option of using a two-point stance from the regular formation, Spread, or Stack.

The Z back aligns a yard outside and a yard behind the Y end in normal, Swap, and Spread formations -- wherever Y is located. Finally, in Stack, he aligns directly behind Y. He can align in the same three-point stance as H or in a two-point, in either case with his inside foot back so he can easily go in motion toward the QB. (I originally lined up H and Z slanted in toward the QB, but found this hindered some pass releases too badly.)

Both H and Z will go in motion on the count of "READY" by the QB, who also employs a heel flick to signal the motion man. The first move from a stance into motion should be smooth but deliberate -- that is, don't explode into motion, or we may be penalized for "simulating action at the snap." The back should be at 75% of his top speed after his second motion step, however. For H when running 11 Fly Sweep (p. 50), this means he must accelerate very quickly before he reaches the spot (roughly behind Spread Guard) where the ball will be snapped. Motion on passing plays will normally continue across the formation, until H has formed the Bunch, or Z has formed Run and Shoot Trips on the Spread side of the formation.

Rocket motion requires different but similar actions from H and Z. H goes in Rocket motion for the 21 Rocket or 22 Sweep and related misdirection plays (p. 62) by drop-stepping and turning his shoulders toward the F back, whose feet he should be just behind and facing the Bunch-side sideline when the ball is snapped (it is important to all Rocket series plays that the motion back NOT be moving backward at the snap). Z, on the other hand, starts in his "normal" 60-series style cross-formation motion on the 29 Rocket and 28 Sweep and related plays. When he reaches BT's outside foot, however, his motion becomes identical to H's on 21/22.

All of our receivers must learn to run precise pass routes -- they should be run to within a few inches of the same spot every time, unless they are being jammed at the line of scrimmage. Even then, our receivers must learn to fight their way back into the "normal" path of their pass route as fast as possible.

The Wild Bunch offense makes H and Z into running/receiving hybrids, and demands a great deal out of both positions in the way of versatility. As previously noted, H must run, block and catch with great facility, and Z must be nearly as versatile.

CHAPTER 7: QUARTERBACK BASICS



I want a smart kid playing QB for me in the Wild Bunch. Quick thinking is an absolute necessity in this offense. His other characteristics can be fairly normal -- but he must be a quick study, and he must be willing to lead. We can coach him to grow in the latter capacity.

Coach Jeff Tedford of the University of California at Berkeley has a very precise checklist of characteristics in mind when he is seeking quarterbacks:

"One, mental and physical toughness. Two, intelligence. Three, competitiveness. Four, athletic or escape dimension, and five would be some type of arm strength or throwing motion. The escape and the arm strength, you can see on tape. The mental and physical toughness, you can see if you go to the game. Watch how they get up. Sometimes, you find out more after they throw: how they get up, how they respond to teammates, how they respond to adversity. When they throw three interceptions, how do they bounce back?"

Coach Al Black's Run and Shoot book (cited p. 4) assigns different priorities to the most crucial characteristics:

"The first thing we look for is a young man with a live arm. Every school has one. This is the most important criterion to becoming a good quarterback. And if this young man also has speed, size, and intelligence, we consider that a bonus."

Coach Black goes on to add that, whatever his blend of talents, the QB must be willing to work hard:

"To rise above the crowd anyone seeking excellence must pay the price of extra effort. A passer must begin to throw in the off season and throw regularly all year in order to be a finished product when the season starts."

One of the keys to becoming a "finished product" is highlighted by Coach June Jones of the University of Hawaii:

"One of the things I found when I was coaching young quarterbacks was that all the good ones had great accuracy. They had different types of arms and strengths, but they were all extremely accurate. The single best thing they had was eye concentration on the target...I want to know whether their eyes are following the football's flight when they throw it or whether they are looking at the receiver until he catches the ball. If you can get them to watch the receiver until he catches the ball, their accuracy will improve tremendously."

Coach Jones has outlined the secret of kinesthetic training for quarterbacks:

"Your brain will tell your hand exactly what you have to do to get the ball from point A to point B."

The first thing for your QB to master is getting up to the LOS right now and getting his hands under center. This forces the defense to be ready immediately for the ball to be snapped -- it also forces their hand quickly if they have any funny business planned.

The QB stance should be no wider than a foot apart. He has some fairly nimble footwork to master, between pivoting and faking in the Fly and Rocket series, and dropping back or rolling out in the passing game. The QB must take countless snaps from both the Center and his principal back-up -- we don't want to be making adjustments for "feel" in the middle of an important game if our starting Center goes down with an injury. If your QB's ever find themselves with free time during practice, have them take snaps from a back-up Center.

The QB has several pass drops he must master, although they are substantially similar in terms of his release from the LOS. As the QB rides forward with the Center's hands to take the ball for a dropback pass, he must start with a deep step off his passing-hand foot (I'll assume he's right-handed for the purposes of these descriptions). The first step should gain almost 2 yards -- it is a big step -- which is the reason for his narrow stance. The first step is taken under control, while concentrating on the defensive coverage. The QB's head should remain pointing downfield even as his shoulders and upper body turn upfield (i.e., back toward his own goal line) as he drops. This sounds difficult, but like anything else can be perfected through practice. We drill the QB on drop, read, and throw until he can do it in his sleep. The second step is just as deep and also along the midline.

On the third step one of two things will happen: the QB will come under control after a shorter third step where he braces against his plant leg and prepares to rock forward and throw the three-step pass in one smooth motion; or else he will start the controlled portion of his five-

step drop, shortening his strides slightly and deciding whether to throw to his initial area or man read, or check to the next receiver. On the fourth step he drops his center of gravity slightly, getting ready to plant on the back leg, roll forward smoothly and deliver the ball on his fifth step.

In half-roll or roll-out passes, the QB drops with the ball rocking across his chest in both hands, ready to bring it up to firing position very quickly. He wants to drop quickly at a 45 degree angle from the LOS for his first three steps, flatten out on his fourth, and make a pass-or-run decision by his fifth step. This is for the full roll-out pass. On a half-roll, he will take his 45 degree drop for two steps, then drop back toward his own goal line on his third and (if necessary) subsequent steps.

Our play-action passes are each different in the kind of fake they require the QB to make, but in each he must give his full concentration to faking well enough to fool the underneath defenders for the crucial first second. After the fake, he snaps his head around and looks for his primary receiver as he drops vertically to gain depth. The QB will probably not have much more time than to read his primary and secondary receivers -- he must be aware that play-action blocking can break down fairly easily, and be prepared to throw the ball quickly.

Pass reads are needlessly complex in many systems, and I have tried to follow a few basic concepts when choosing or designing plays for the Wild Bunch. Coach Homer Smith (www.homersmith.net) is a great authority on all aspects of offensive football, and I highly recommend his site and his outstanding 17-volume football manual series to all students of the game. The following points are borrowed from his Homer Smith on Coaching Offensive Football: Organizing Pass Patterns (Manual 7 of 17), and underpin the Wild Bunch passing game:

- Passers get snapshots of the defense, not video clips -- their eyes stop and start, fixing on receivers, defenders, or areas/gaps between defenders;
- With rhythmic fixes, a passer can see the whole field in the time that decent pass protection will provide him -- say, 2.5 seconds.
- A passer can sense danger based on past conditioning (i.e., interceptions), and his reflexes can stop him from throwing the ball into danger;
- Learning to check his throws (pump-fake) and look off defenders is more important than "quick release", passer height, high ball release, etc.;
- Passers should look at an area only for a fraction of a second to prevent giving defenders easy reads;

- Therefore, pass routes must be packaged together in a way that allows the passer to sequentially read the defense in quick fixes.

That last point is important to play design -- it means not asking your QB to read the right CB, and then suddenly switch his read to the left OLB. Whenever possible, reads should flow in one direction -- right to left, or deep to shallow.

READING COVERAGES

The first thing I want to explain is what I expect of my coaching staff and of my quarterbacks when it comes to recognizing and reading defensive coverage schemes. When it comes to recognizing coverages, that is a job for me and/or my coaching staff. We want to take as much off of our QBs' shoulders as possible. We ask of them only two things:

- 1) PRE-SNAP: To be able to determine whether a safety is present in the middle of the field (Middle of Field Closed/MOFC: Cover 1/Cover 3) or not (Middle of Field Open/MOFO: Cover 0, Cover 2 family, Cover 4); and
- 2) POST-SNAP: To be able to read a defender and throw to one of two receivers based on his actions (against zone coverages) OR to track a receiver and throw him the ball if and when he is open (against man coverage).

That's it. All the responsibility for determining whether the defense is dropping from its Cover 2 shell into C2, C4, C5 (C2/Man Under), C2-Robber or C2-Tampa is on my shoulders and those of my offensive staff. That means if the play calling is sub-optimal, it isn't the QB's fault, and we do not depend on him to rescue us from such situations on a regular basis. This does not absolve our QB's from learning about defensive recognition, of course -- the following pages contain copies of the coverage diagrams with which we drill our QB's -- but the responsibility for recognition and play-calling before the snap lies with the coaching staff. Our players must only recognize MOFC/MOFO before the snap and execute their assignments as best they can after it.

The diagrams which follow describe roughly 95% of all coverages we see in an average season. They form an excellent primer for quarterbacks to study defensive intentions.

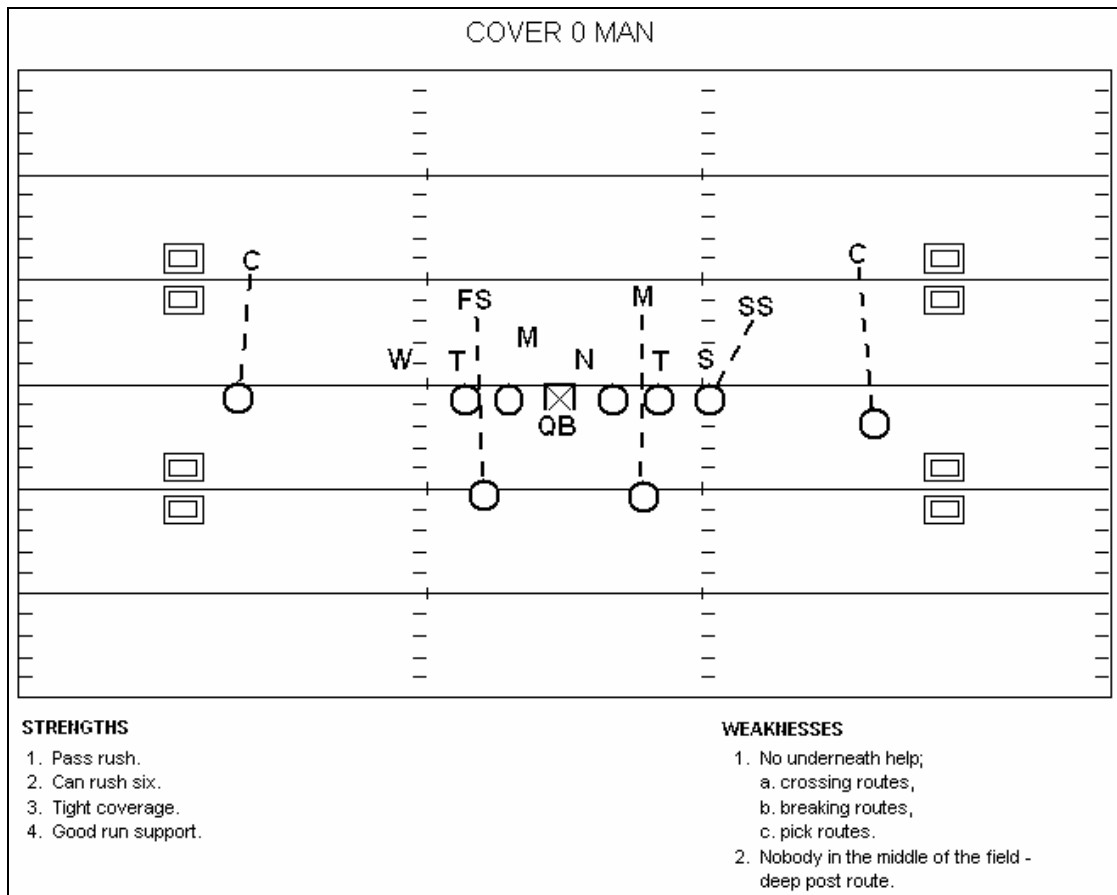

COVER 0 -- Blitz/Man (MOFO)

The lack of any safety man should scream "BLITZ!" to your QB. This suggests that we as coaches should be looking at pass route packages designed to hit quickly and/or exploit the hole in the deep middle, and that the QB must be prepared to throw the ball right away when pressure comes. Some good candidates for attacking C0, all of which offer quick targets to the QB, are:

- 51 Y Cross
- 63 Go
- 64 Out
- 74 Mesh

...and don't forget the Rocket series. Both 21 Rocket Sweep and 20 Choice should be excellent calls against pressure from the middle of the defense.

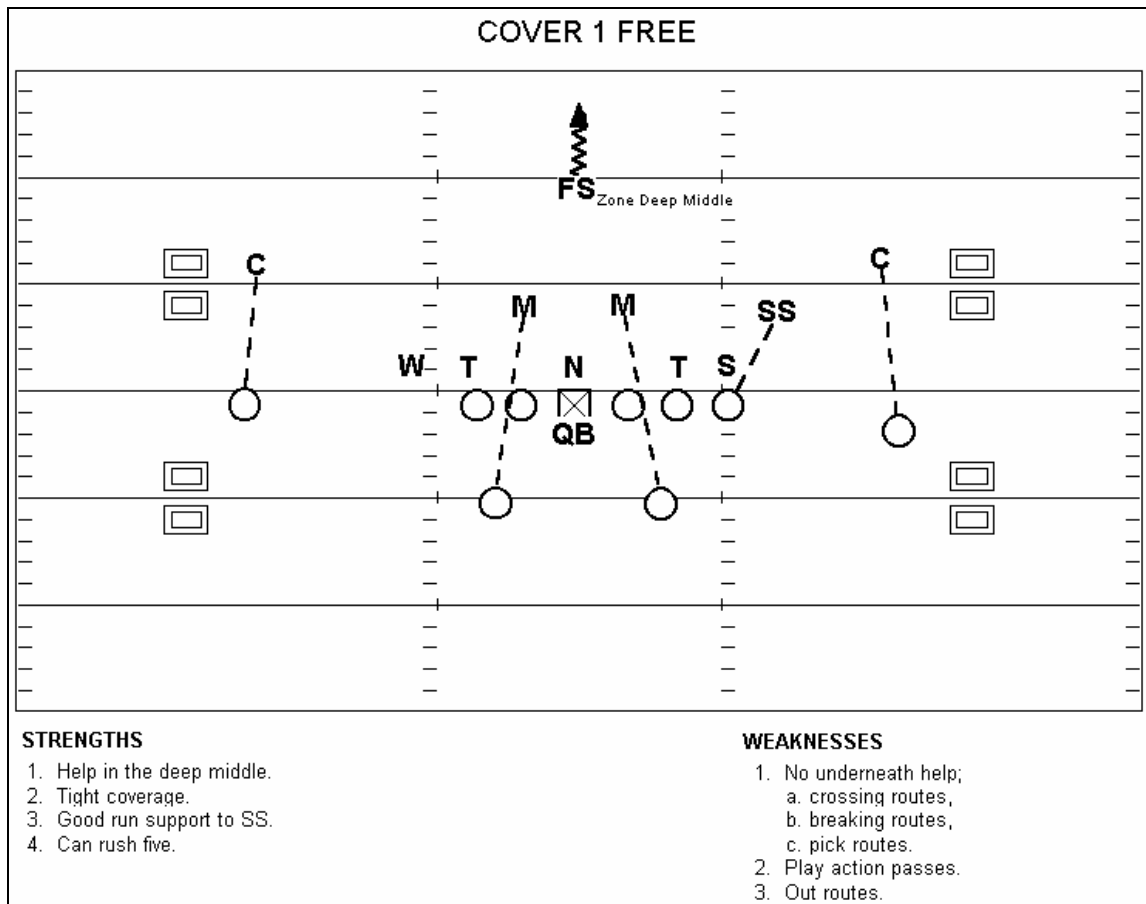

Cover 1 -- Man/Free Safety (MOFC)

It can be difficult to determine whether a defense is playing man (Cover 1) or zone (Cover 3) coverage based solely on the presence of a safety in the deep middle of the field -- this is why we as coaches keep the responsibility for understanding our opponents' coverage tendencies, and ask only a few simple reads of our quarterbacks. A play like 62 Flag (p. 100) can help sort out the coverage in a big hurry, and provides answers whether the defense is playing C1 or C3.

Other good C1 choices:

- 74 Mesh/70 Arrow/75 Shallow
- 76 Switch
- 71 Niner
- 64 Out

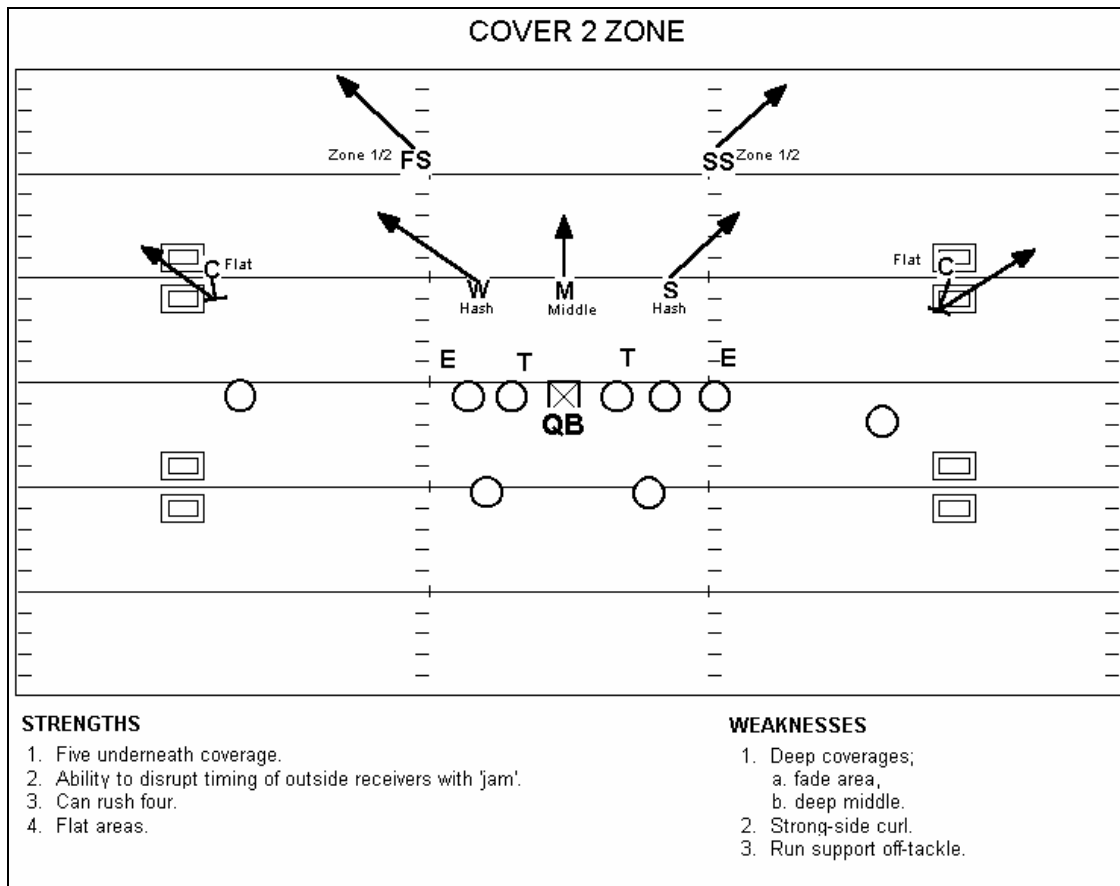

The deep middle hole is an inviting target, but beware of robbers (p. 42) and dropping LB's (p. 43) who are trying to bait you into throwing the Post.

In attacking Cover 2 we look at the Post, of course, but also at the deep outside zones near the edge of the field, at bracketing the playside flat defender with a horizontal stretch, and also at attacking the heart of the defense -- run the ball!

- 50 Seam
- 52 Smash
- 74 Mesh
- 76 Switch
- 63 Go
- 35-60
- 14/16 Dive
- 25/27 Belly

(NOTE: Cover 5 is simply Cover 2 deep, with man-to-man defense by the five underneath pass defenders on the five potential pass receivers. Treat it as you would Cover 1, with crossing routes and rubs to free up receivers from tight man coverage.)

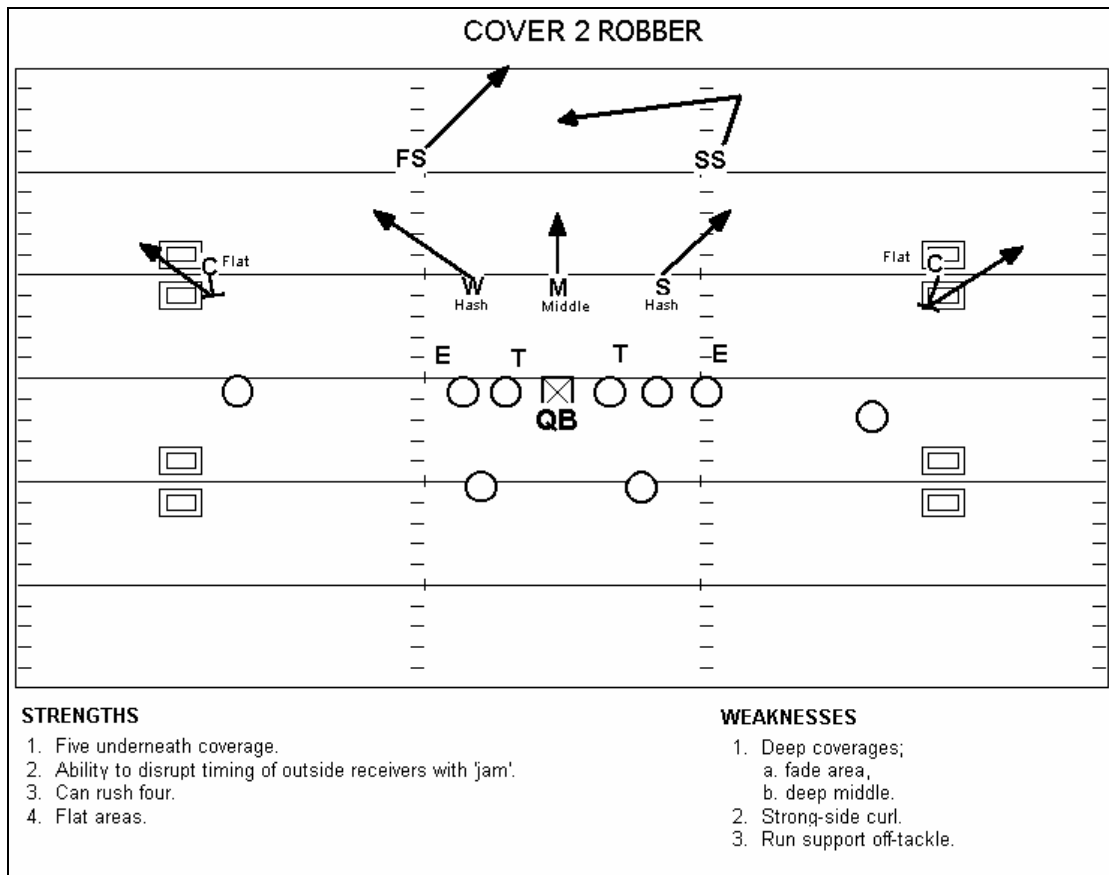

C2 Robber - Danger -- Delayed MOFC!

Designed to get greedy OC's throwing the deep Post every time. It suffers from the same defects as most hybrid coverages -- it works great if the offense falls into the trap of trying for the deep middle, but it leaves the deep outside thirds of the field undefended.

Some good choices against defenses that try to rob from a C2 shell:

- 52 Smash
- 62 Flag
- 63 Go
- 74 Mesh
- 76 Switch

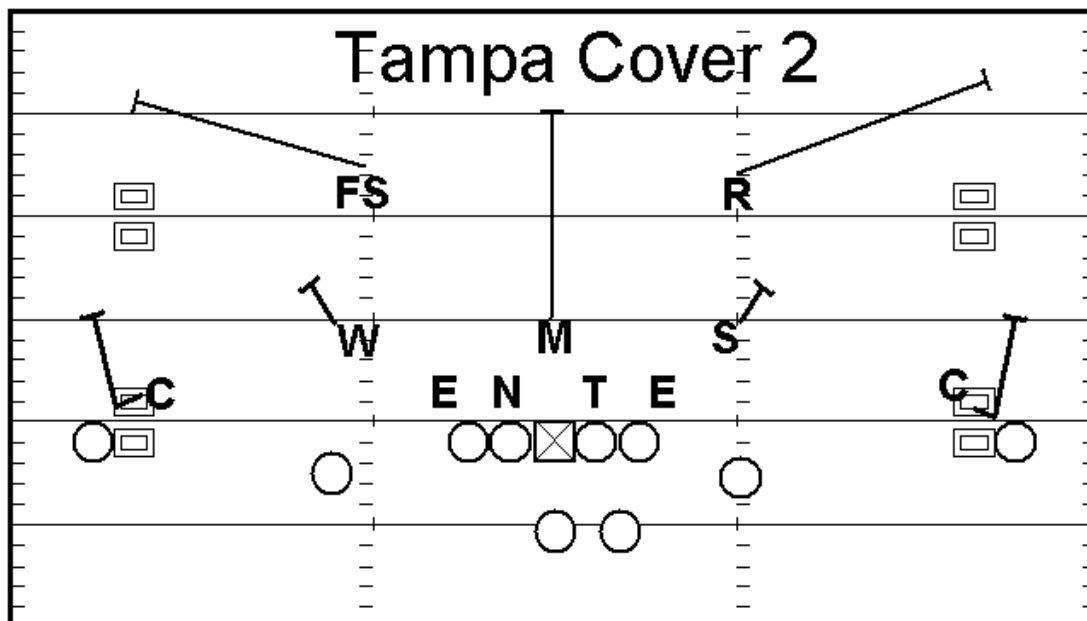

Tampa 2, which is the coverage the Buccaneers have made famous. The difference is the corners funnel #1 outside, then open to the ball and gain depth with eyes on #2's depth. The safeties play with extra width and must work to get over #1. The MLB opens to passing strength and gains depth of up to 25 yards. If #2 is vertical up the seam, the MLB will work for inside leverage. Really looking like a cover 3 coverage. The OLB's work to the hashes and get their eyes on the QB. They will break on the QB's vision and action. They are not concerned with a defined area of the field, but rather the ability to break on all underneath routes. This coverage is often called with a 3-man line game. Typically run out of an over front (3/9 tech. to strength, 1/5 tech weak), the front will run what we call a "Buc" or what has also been called a "Pirate" game. The 3 tech. slants into strong A, the 9 or 8 slants into the strong B. The 1 plays his weak A, and on pass works to loop around for contain on pass set. The LB play is critical with this line game. The SLB is now responsible of C gap, but must spill the ball outside (take block on with outside shoulder), allowing the MLB to run free over the top to run down the ball. If the SLB takes the block on with the inside, and along with the hard inside slants of the DL, the gap created is too big to cover for the MLB. This line game, along with the SLB being responsible for C gap, allows the MLB to get his eyes on the TE right away. The advantage is for the 21 personnel, Pro set, where the passing strength is to the TE. The MLB is responsible to run with inside leverage, which in this formation is the TE. This was a great call for us vs. the 2-back run and passing game. If you are going to run it, you have to be committed to it. As it takes a lot of time to get good at, but it is well worth it. The Bucs and Rams run it quite a bit in the NFL and would be great places to see it run. A great compliment coverage with this is Cover 1 (man-free). Again, the Bucs run this quite a bit with Lynch walking down as the 8th man in the box.

Taken from FootballScoop.com message board

C2 Tampa - Another MOFC Disguise

See the description above. If you have a Mike backer who can make that deep drop quickly and effectively, great -- but you'd better have a replacement ready for him in the second half to give him a breather.

On offense, we treat this as Cover 3 with no short middle defender -- 62 Flag is a great choice against this look.

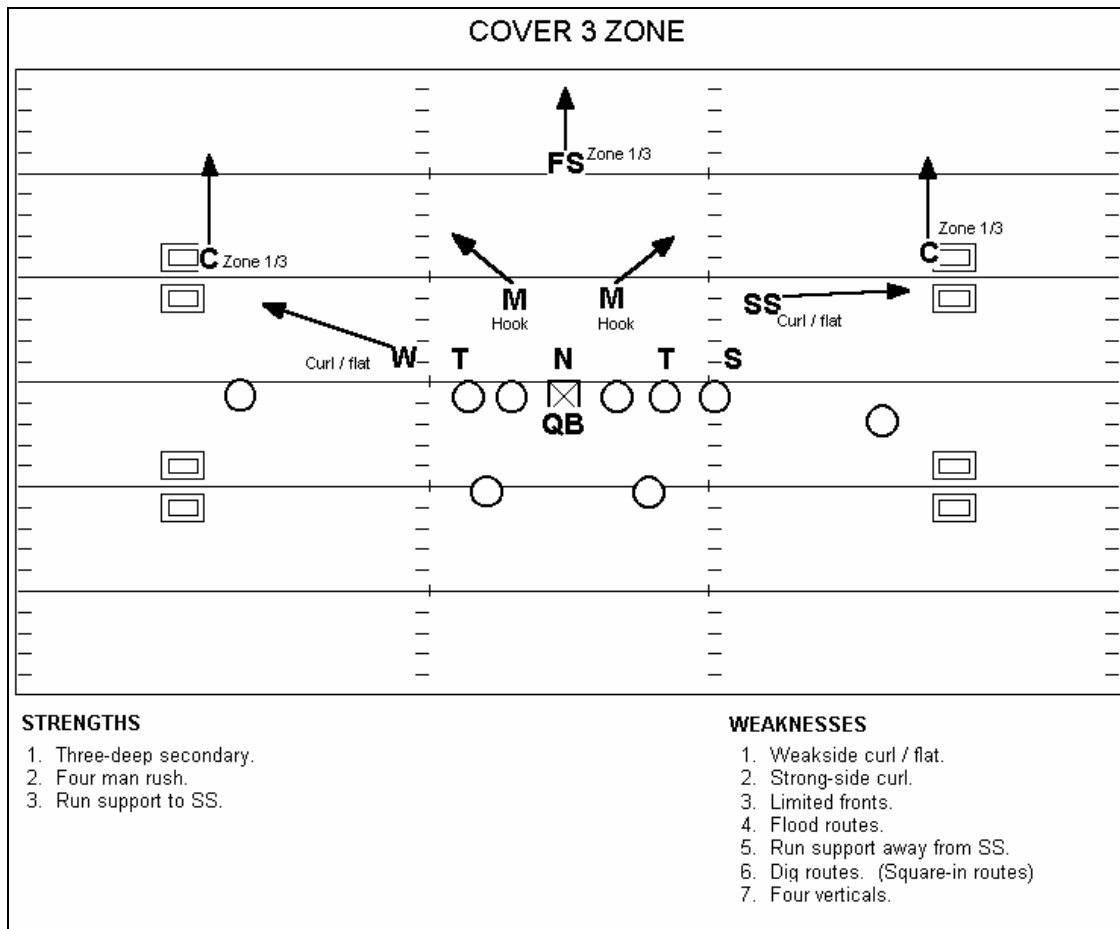

Cover 3 - 3 Deep Zone (MOFC)

The standard coverage for most 8-man front defenses. It can be attacked deep with 4 verticals, or underneath by finding the seams between the four underneath zone defenders. Floods and crosses are both good, as are routes that stretch the coverage horizontally by attacking the edge of the field. 63 Go (p. 101) is a classic anti-C3 weapon which isolates and brackets the strong flat defender with two receivers.

Some other good choices:

- 50 Seam
- 65 In
- 74 Mesh

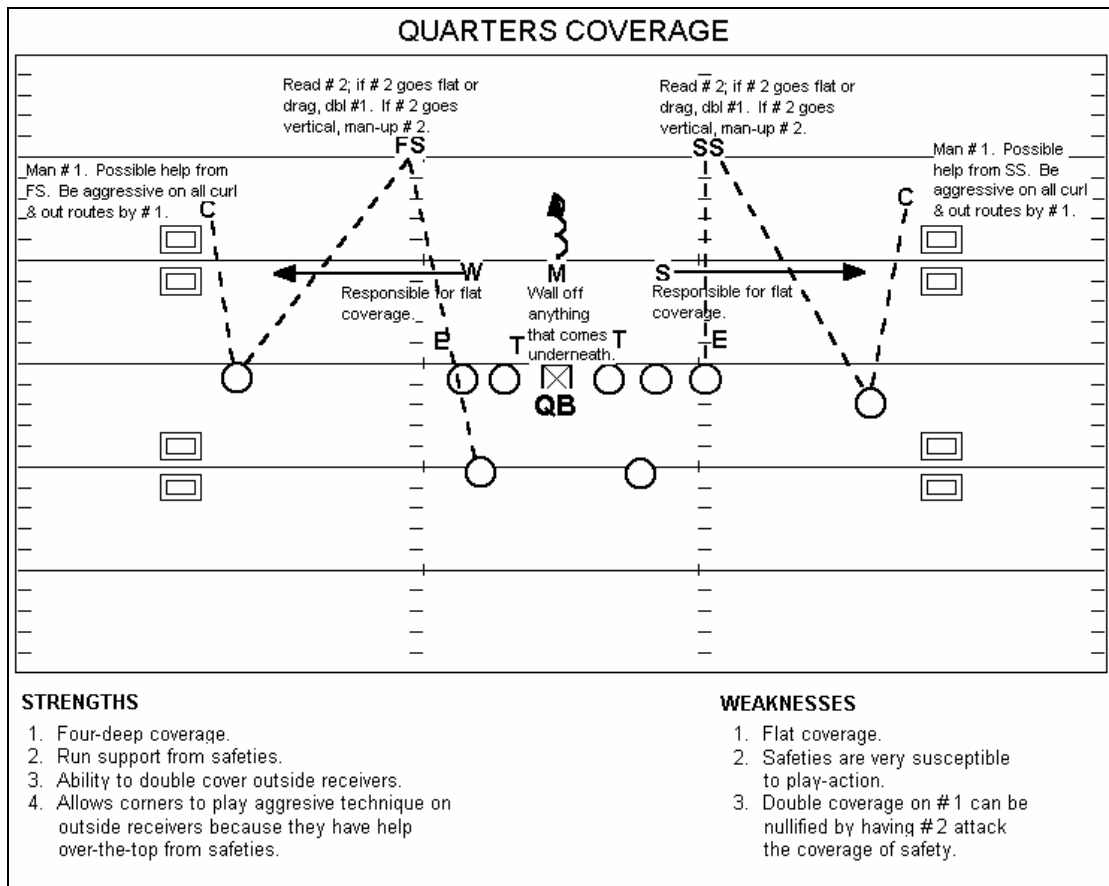

Cover 4 - Match-Up Zone from C2 Shell (MOFO)

Cover 4, or Quarters coverage, gives extra help deep at the expense of underneath coverage. It can be recognized fairly easily by the relatively close alignment the safeties take to the LOS and by their flat-footed stance as they read run first. Good play action will usually catch one or both safeties out of position coming up to stop the "run".

Some good ways to attack C4:

- 74 Mesh
- 76 Switch
- 17 Dig
- 24 Sluggo
- 30 Over

THE QB IN THE RUNNING GAME: The Wild Bunch makes few special demands on the QB when it comes to executing the running game, although he must drill his timing on the Fly Sweep series until he can literally run the play with his eyes closed. While Coach Speckman noted in Chapter 1 that the Fly series is very forgiving, it is the QB who must be ready to adjust if the sweeper is too close or too far from him at the snap to make a smooth hand-off on the Sweep. We use skeleton backfield drills to teach the timing of all our running plays, but especially to perfect the timing of the Fly Sweep series. Using some kind of template for the offensive line, so the backs can run these drills while the linemen are also getting useful practice, saves a great deal of practice time (this is the old "fire-hose drill", with the spacing between linemen drawn on a piece of flat canvas or plastic, which the backs can use to space and time their plays). The backfield skeleton can practice all running plays, pass drops, draws, screens and play action fakes on a rotating basis -- run briskly enough, this is both great conditioning work and an excellent way to get in hundreds of play reps in short order. This same method is also excellent for practicing the Rocket Sweep pitch technique and fakes and hand-offs for the complementary plays.

The best single advice I can give you about coaching your quarterbacks (and other backs and receivers, and to a lesser extent linemen) to master the Wild Bunch is to invest in some of the videos from coaches who are primary sources for my offense. All of the following are available from Coaches Choice (<http://www.coacheschoice.com>):

Andrew Coverdale and Dan Robinson:

The Bunch Attack: Using Compressed Formations in the Passing Game

The Quick Passing Game: Basic Routes

The Quick Passing Game: Advanced Routes

Mark Speckman:

Coaching the Fly Offense

Running Back Drills for the Fly Offense

I realize that, at \$40 each, these videos are not cheap. They are, however, absolutely indispensable in teaching the skills needed to run an effective Wild Bunch offense. More correctly stated, they teach HOW to teach these skills, with both chalkboard X and O theory and videotaped on-the-field practice layouts. I highly recommend them all, but the Bunch Attack and Running Back Drills tapes are the most important ones for getting a Wild Bunch offense off the ground.

In addition, Coach Chuck Klausing offers an excellent playbook and video cut-up package on the Rocket and Jet Sweep (the Wing-T version of the Fly Sweep) series -- you can contact Coach Klausing at clk5401@earthlink.net.

CHAPTER 8: THE PLAYS

10 - 30 SERIES: THE RUNNING PLAYS:

Our running game comes in three series. First is the Fly Sweep (10) series, which consists of the Sweep (11/19), Dive (14/16), Truck (1X), Crash (1X) and Slam (1X) plays. 18 Boot, 17 Dig, and 1X Flood provide the play-action component for the series. 15 Triple is an odd bird, part play-action pass and part option -- but not by the QB. See page 49 for a diagram of how the plays relate to each other. Truck, Crash and Slam are incompletely numbered because coaches are free to choose one or more of these counter plays -- it isn't necessary to run all three.

The second part of the running game is the Rocket Sweep (20) series. The Rocket only requires blocks outside the C gap to make the play go, so we usually block it Outside Zone and tell our kids to "reach and run" to cut off pursuit. The Rocket Sweep itself (21/29) is complemented by the Waggle (26) and by quick passes against the flow of motion (20). Another set of plays uses Rocket motion, but sends the F back with, rather than against, motion. In 22/28 Belly Sweep, the F back fakes into the playside A and B gaps. The inside complement comes in the form of the 25 and 27 Belly plays. 22 Post provides play action off the Belly Sweep. There is also an excellent counter to H off the 28 Belly Sweep action (23 Tackle Trap) and great play action off the counter (24 Sluggo).

Finally, the Inside (30) series consists mainly of the inside attack to the F back -- Quick Trap (35), Zone (36), Counter (34), and play action off Quick Trap (30 Over) and Zone (39 Boot). These plays were taken from the Run and Shoot (Quick Trap) and the modern one-back (Zone and Counter) offenses. They are designed to attack the middle of the defense whenever it weakens itself by moving players out wide to guard the defensive flanks against the wide running and quick passing portions of the Wild Bunch attack. Two other inside plays, 37 Lead and 38 Ice, run F through the Spread-side B gap with lead blocks by Y/Z and H, respectively. Finally, there are the designed quarterback runs: the QB Wedge (32) and the QB Draw (33), which also hit in between the guards.

About play action: If I had to describe the ideal sequence for calling different kinds of passes and runs, it would be this: When they expect you to run, either throw a play-action pass, or run misdirection away from where they expect you to run. When they expect you to pass, either run, or else throw a pass that takes advantage of their passing expectations. Never throw a play action pass in an obvious passing situation. (If I ran a fake draw pass, I might alter that rule, but I don't.) We have play action passes that resemble most of our core running plays, and we will not hesitate to use them on "running" downs from anywhere on the field. I consider the play action pass to be the best and easiest way to throw the "home run" pass -- one that will either score or radically change the field position equation with one throw.

| <u>SERIES/PLAY</u> | <u>PAGE</u> |
|--------------------|-------------|
| <u>10 FLY:</u> | |
| 11/19 Sweep | 50 |
| 14/16 Dive | 53 |
| 1X Truck | 55 |
| 1X Crash | 56 |
| 18 Boot | 57 |
| 15 Triple | 58 |
| 17 Dig | 59 |
| 1X Flood | 60 |
| 1X Slam | 61 |
| | |
| <u>20 ROCKET:</u> | |
| 21/29 Rocket Sweep | 62 |
| 20 Choice | 64 |
| 26 Waggle | 65 |
| 22/28 Belly Sweep | 66 |
| 23 Tackle Trap | 68 |
| 25 Belly | 69 |
| 27 Belly | 70 |
| 22 Post | 71 |
| 24 Sluggo | 72 |
| | |
| <u>30 INSIDE:</u> | |
| 35 Quick Trap | 73 |
| 36 Zone | 75 |
| 34 Counter | 77 |
| 30 Over | 79 |
| 32 QB Wedge | 81 |
| 33 QB Draw | 82 |
| 39 Boot | 83 |
| 37 Lead | 84 |
| 38 Ice | 85 |

WILD BUNCH: BREAKDOWN OF 10-30 SERIES

| <u>CORE PLAY</u> | <u>PAGE</u> | <u>COUNTER</u> | <u>PAGE</u> | <u>PLAY-ACTION (CORE)</u> | <u>PAGE</u> | <u>P-A (COUNTER)</u> | <u>PAGE</u> | <u>P-A (P-A)</u> | <u>PAGE</u> |
|--------------------|-------------|----------------|-------------|---------------------------|-------------|----------------------|-------------|------------------|-------------|
| 11/19 FLY SWEEP | 50 | 14/16 DIVE | 53 | 18 BOOT | 57 | | | | |
| | | | | 17 DIG | 59 | | | | |
| | | | | 15 TRIPLE | 58 | | | | |
| | | 1X TRUCK | 55 | | | | | | |
| | | 1X SLAM | 61 | | | | | | |
| | | 1X CRASH | 56 | | | 1X FLOOD | 60 | | |
| ----- | | | | | | | | | |
| 21/29 ROCKET SWEEP | 62 | | | 20 CHOICE | 64 | | | 26 WAGGLE | 65 |
| 22/28 BELLY SWEEP | 66 | 25/27 BELLY | 69/70 | 22 POST | 71 | | | | |
| | | 23 TACKLE TRAP | 68 | | | 24 SLUGGO | 72 | | |
| ----- | | | | | | | | | |
| 35 QUICK TRAP | 73 | | | 30 OVER | 79 | | | | |
| 36 ZONE | 75 | 34 COUNTER | 77 | 39 BOOT | 83 | | | | |
| ----- | | | | | | | | | |
| 32 QB WEDGE | 81 | | | | | | | | |
| 33 QB DRAW | 82 | | | | | | | | |
| 37 LEAD | 84 | | | | | | | | |
| 38 ICE | 85 | | | | | | | | |

THIRD EDITION
January 2006

11/19 FLY SWEEP

The Fly Sweep series was the catalyst for the Wild Bunch offense, and it remains the indispensable link between the motion we use to run our 60, 70, and 80 series passes (p. 86) and our Fly running and play-action passing games.

I believe there is a great advantage in starting plays off identically, and forcing the defense to guess when, where, and whether we will deliver the football. Whether it is the quick, two-step motion H takes before the ball is snapped for 11 Fly Sweep, or the longer, more deliberate motion of Z as he crosses the formation for 19 Fly Sweep, the start of our Fly Sweep series plays commands the attention of the defense.

A corollary to our "unity of apparent intent" with the Fly Sweep series is for our flank players (X, Y and Z) to release deep on the Fly Sweep and Dive plays (when Z is not the ball carrier, of course). This makes it harder for the pass defenders on the flanks to read pass or run in the crucial first second of the play, and almost impossible for them to distinguish between the Fly Sweep and Dive and their play-action pass analogues (18 Boot and 17 Dig - pp. 57 and 59).

As early as 2000, Wild Bunch coaches were seeing defenses respond to the dual threats of pass and run inherent in our cross-formation motion by waiting until the motion back passed beyond the reach of the QB to drop back into a pass defense posture to the motion side of the field. There are various viable responses to a tactic like this, and one of my favorites appears here as 1X Crash (p. 56).

Another predictable reaction on defense is to send the EMLOS defender charging hard upfield at the snap after he sees Fly motion. An excellent answer is to blindside him with the motioning back, then run the F back inside him: see 1X Slam, p. 61.

The keys to a successful Fly Sweep are few, but crucial. The backs must practice the timing and execution of their steps and fakes until they can practically run the play blindfolded. Setting up a "fire-hose" drill (p. 46), or otherwise marking the proper path and steps for each back, is a great teaching aid for backfield drills and cuts down on learning time. Make your backs take pride in the quality of their faking, and your Fly series will take off fast.

One of the best practice tips I know of for running the Fly series is to use a basketball in place of the football when your backs are working on their Fly fakes. If you can fool a coach's watchful eye (not to mention a linebacker's) when faking with a basketball, you are ready to run the Fly series under game conditions. (Thanks to Coach Todd Bross of Union, ME for the tip.)

THIRD EDITION
January 2006

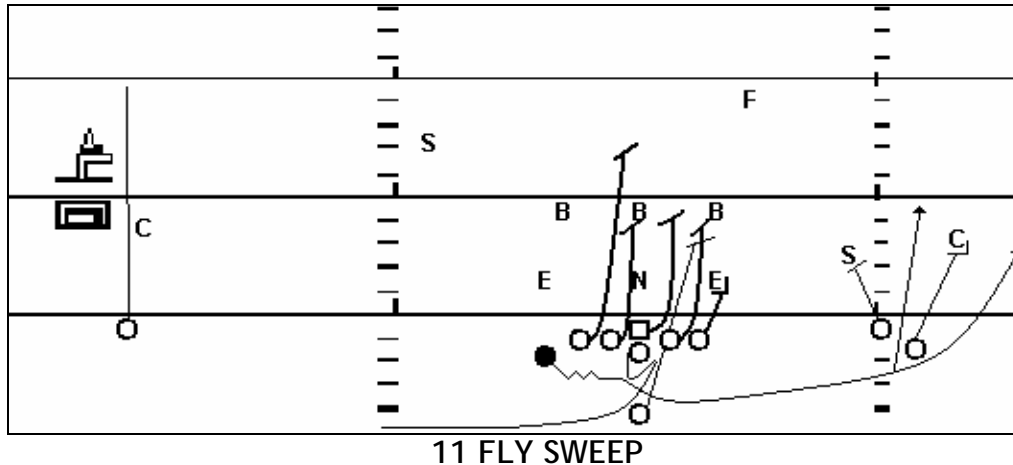

The crucial blocks for 11 and 19 Fly Sweep occur outside the B gap, especially at or near the LOS. In the diagram above, the Bunch Tackle must make that reach block on the EMLOS defender, in this case a 3-3 Stack DE. The good news is that he only has to slow the DE down in order to make the play work. Y and Z need to sustain their blocks until 3 seconds after the snap if we are going to make more than the minimum 4 yards per carry on the Fly Sweep -- and we want 6-8 yards on a regular basis from this play.

The line blocks on tracks through to the second and third levels from the playside guard to the backside tackle. Step through the playside gap and find the most dangerous shirt of the wrong color to block downfield. Cut off enough pursuit and the 6-8 yard Fly Sweep will turn into a big play.

The QB reverse pivots, meshes shoulders with the motion back as he hands off, then fakes the 14/16 Dive to the FB. Finally, he braces off his front foot, and accelerates into a bootleg away from the playside, reading the reaction of the backside EMLOS defender to set up 18 Boot (p. 57). (As Homer Smith points out, defenders respond to accelerating offensive players - so always accelerate on your bootleg fakes.)

Because H's motion is so quick, the defense will tend to react strongly to it. It is very important that his first step is deliberate rather than explosive, to avoid "simulating action at the snap" penalties. However, he must gain as much speed and momentum with his next step as possible -- we call it a "delayed explosion."

Among the other things I have changed since the first edition of the Wild Bunch book is to eliminate the pulling playside guard as an option -- I prefer to block the Fly Sweep as diagrammed above and on the next page. We might decide to pull the guard under very exceptional circumstances, but I am convinced that maintaining the "unity of apparent intent" between the Fly Sweep and Dive plays is by far the most important criterion for choosing a blocking scheme for the Fly. Ergo, no pulling guard.

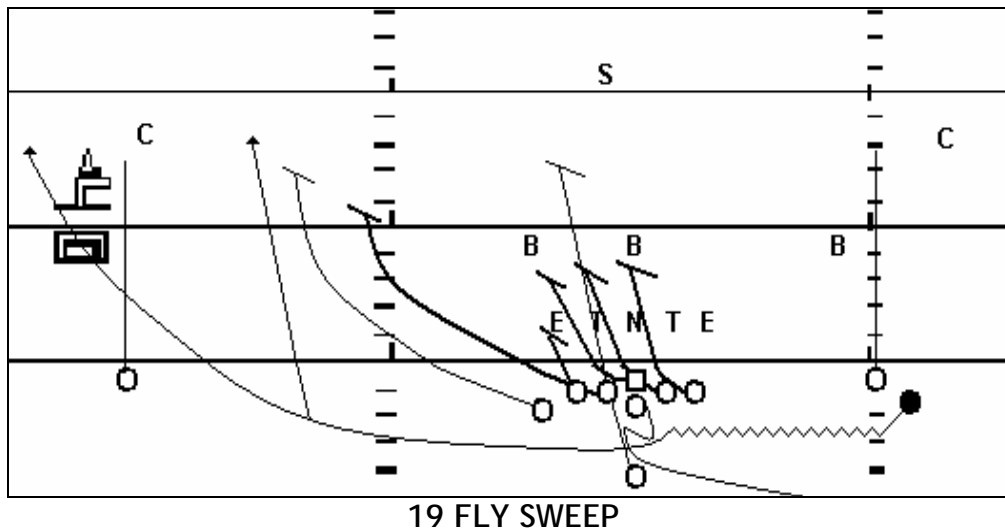

Against 8-man fronts like the 5-3 diagrammed above, the Fly Sweep becomes the preferred base play to attack on the ground (along with the Rocket sweep -- see p. 62). With the defensive strength located between the tackles, we would be really stupid not to try and get outside with speed, either on the ground or through our flank passing and play-action games.

You will notice that the Spread Guard appears to be pulling in the above diagram. In fact, he is track-blocking at an angle that will allow him to pick up the OLB playing over H. It is also possible for him to pull flat down the line to block a wider defender, if we should decide by game plan that this is necessary or desirable. The key point, however, is that Spread Tackle must be able to reach his man for this play to work consistently. The other points are details.

14/16 DIVE

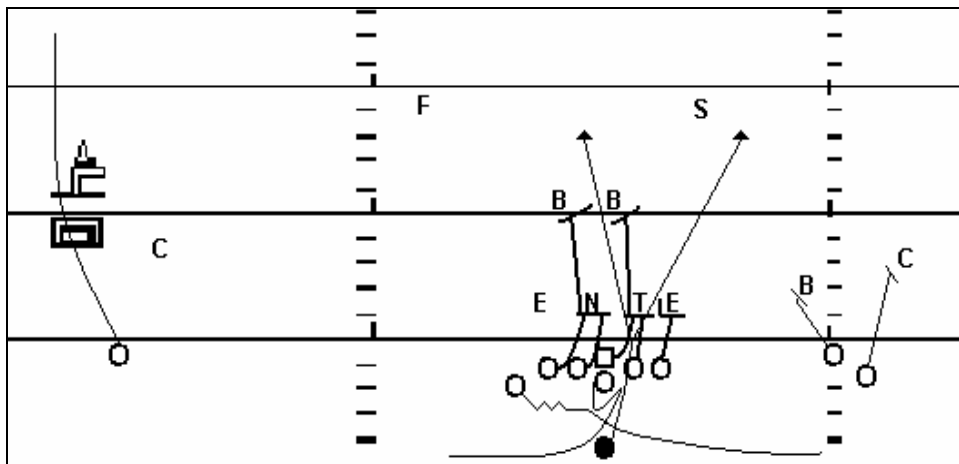

14 DIVE

The inside complement to Fly Sweep uses our Inside Zone blocking principles in order to get a helmet on each of their helmets to the playside of the defensive interior. With a natural flow of the defense to the motion side in response to the Fly Sweep threat, and the bootleg action by the QB to control the backside EMLOS defender, we have had great success with the Dive play. Some games, in fact, we have averaged more yards with the Dive than with the Fly Sweep.

Linemen step playside, either to the outside earhole of the DL over them if they are covered, or through their playside gap and on a track toward the second level if they are uncovered. As with the Fly Sweep, we ask the flank players not actually carrying the ball (X, Y, and sometimes Z) to release downfield as though for a deep pass route, then to break down and stalk block their defender once they react up to the ball carrier.

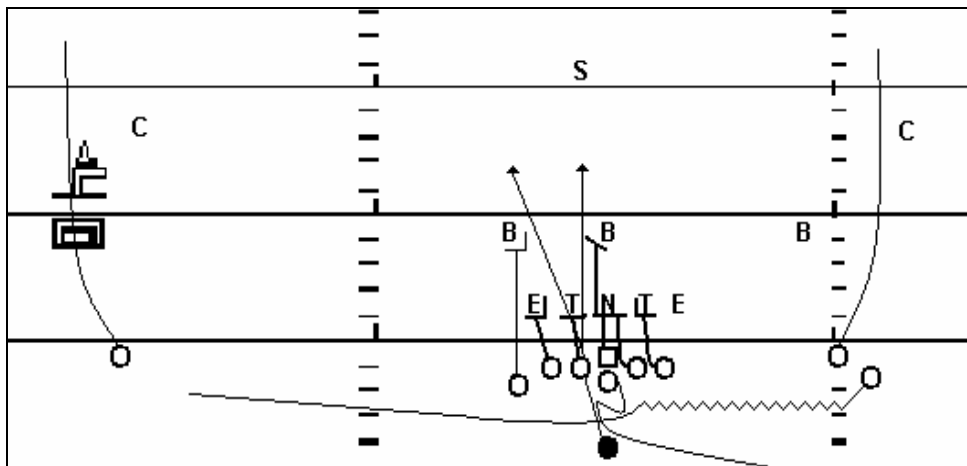

16 DIVE

Something about running the Fly Sweep series to the Spread side of the formation seems to really capture the attention of the defense. Maybe it is the longer motion by Z as he crosses the formation which gives defenders more time to fixate on the idea of the Fly Sweep. Whatever the reason, 16 Dive has been a very successful play from its inception, because defenses seem to react faster and harder to the outside threat to the Spread side of the formation than they do to the Bunch side.

One practical result is that it is easy to block an 8-man front from 16 Dive, even though the numbers would seem to favor the defense. The defensive reaction to the outside threat on the Spread flank means, however, that your linemen often end up walling off defenders who are already on their way past the point of attack.

1X CRASH

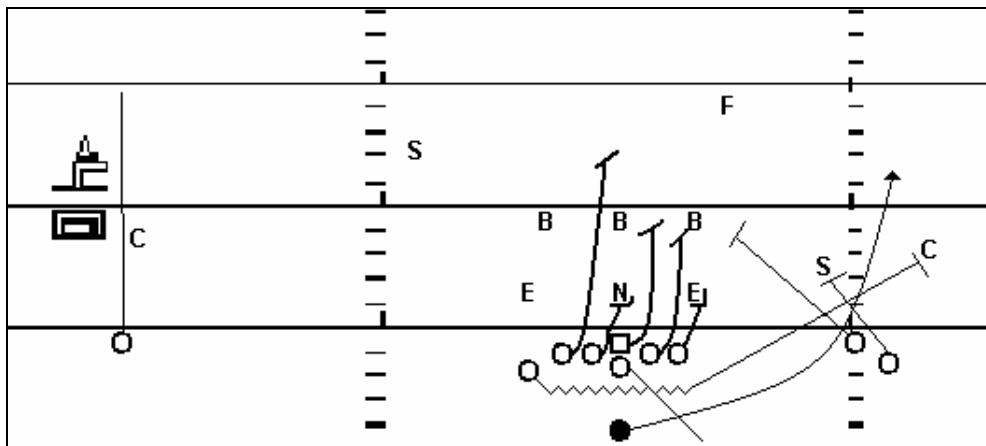

Coach Nick Cursley, formerly of Kent Exiles in England, reports that the combination of Bunch passing and the Fly Sweep has caused an interesting defensive reaction. The defense waits until after H has passed behind the QB, then drops into an over-shifted pass coverage to the Bunch side only. Coach Cursley's response was straightforward, but perfect -- when they give you a soft corner, you have to exploit it. In Crash, the ball is snapped when H passes behind the QB, who open-pivots and hands to the F back. He follows his lead blocker, H, and cuts off his block. Y cracks the man tracking H, while Z looks for the first short defender inside him, and H blocks the first color that shows past Z. The line blocks Outside Zone, looking to "reach and run" on the defense. As with 11 and 19 Fly Sweep, the block on the 5 technique EMLOS defender is crucial.

Alternately, we can snap the ball a count later, block H on the DE, and pull the tackle for the cornerback.

This play can be used in many situations, of course. Among other things, it is a nice way to give your F back some carries to the outside if he has any foot speed. It also sets up a very nice play-action pass to the Bunch side from a roll-out action by the QB, and can even be made a run-pass option. If Crash becomes an integral part of your running game, consider adding its play action complement to your attack. An out-breaking Flood pass route package can be especially effective, with the F back blocking the EMLOS defender after a hand-off fake. See 1X Flood, page 60.

18 BOOT

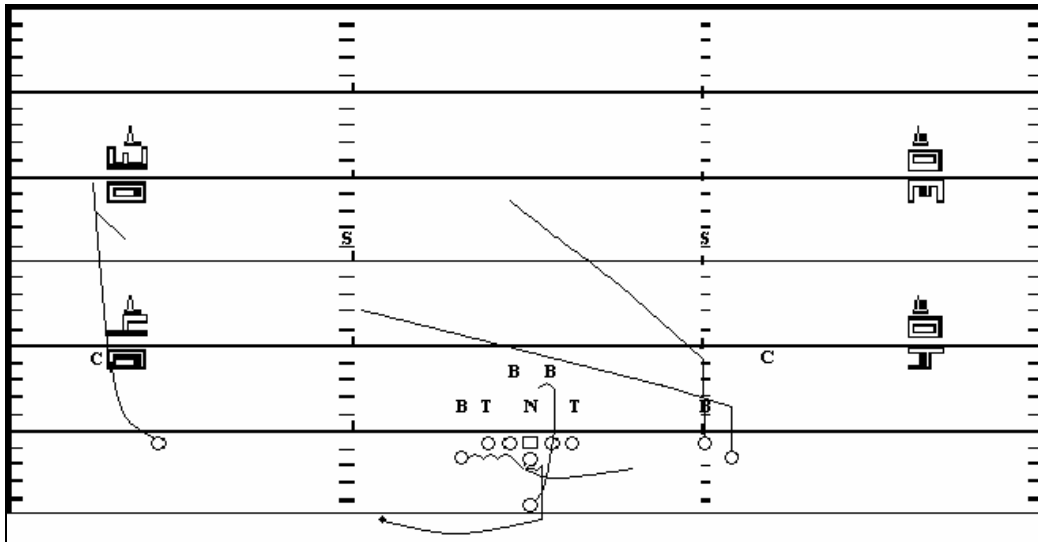

Play action from the 11 Fly Sweep and 14 Dive sequence. QB reverses out, spin-fakes to H while keeping the ball in close (no hand-fake), then flash-fakes the ball in and out of the F back's pocket. Finally, he rolls to the Spread side. X has taken an Outside Vertical release, reading the PCB. If the PCB gains depth with him, he will break off to a Hitch at +12. If the PCB levels or stumbles, X will continue down the bottom of the numbers. Z runs a Shallow Cross and Y a quick Post. Z is the "Q" receiver against blitzes, although QB should be able to run away from any inside pressure. This is naked, so QB must observe the backside EMLOS rush angle every time we run 11 and 14. F replaces the ILB if he drops. If we can get our QB outside of containment with the ball, we feel we have a good play no matter what the defense does -- this is one of the few plays we consider coverage-proof. X is the primary, coming back if his defender plays it too deep, or taking off down the numbers for the deep shot if he can run by a tight corner.

Z's Shallow Cross may be open early if the short defenders bite on the Sweep/Dive fakes, while Y's quick Post has a chance if the outside defenders don't recover quickly enough from the fake. H also has some interesting possibilities -- often he will come through untouched. If so, he should cut downfield in a Wheel route behind Y, looking for the ball as soon as he's headed downfield. This gives QB a "transcontinental" throwback opportunity if no one accounts for H. We can also adjust this play for the red zone, calling 18 Waggle, which tells Bunch Guard to pull and lead for the QB. Y will cut back his route to the Corner after breaking to the Post, to give the QB a throwback opportunity and to stretch the defense across the entire width of the field.

15 TRIPLE

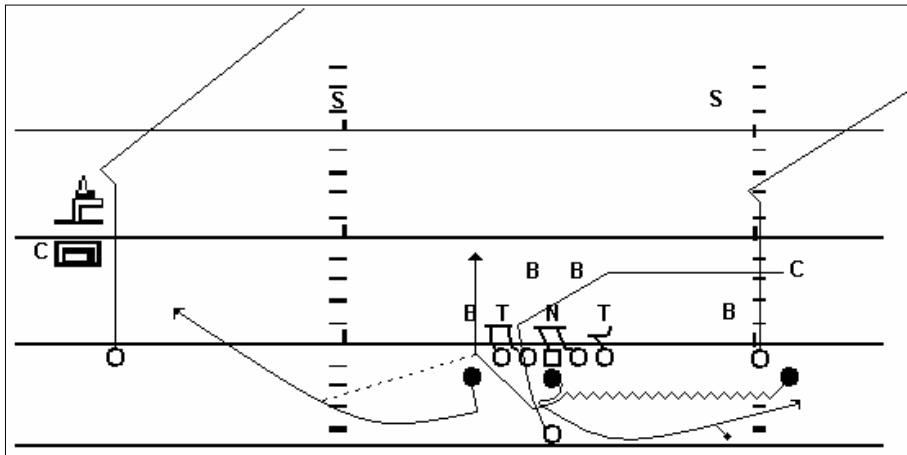

This is a counter to the 19 Fly Sweep that is also a play-action pass. It was inspired by Penn State's use of a freshman option QB (Michael Robinson) at a WR position. It could be used in the Wild Bunch to take advantage of defenses that send someone across the formation with the motion man to counter the Fly Sweep, but it adds a dimension that a basic bootleg doesn't have -- the option play to the Spread side.

The QB reads the reaction of the defense as Z goes in motion. If no defender follows Z across in motion, the QB hands the ball to Z after the snap, fakes 16 Dive, and fakes his bootleg roll to the Bunch side. H drop steps and gains an option-pitch relationship to Z. Z options the EMLOS defender. If Z keeps, H should follow him downfield, maintaining the proper 4x2 yard relationship to him, looking for a late pitch. If H has a decent throwing arm, he can also throw a pass to X or Z after taking the option pitch. An excellent special has H stopping and throwing back to the QB on a Wheel route.

If a defender comes across the formation with Z (either in man coverage or through secondary rotation with motion), QB takes the snap, fakes to Z, and bootlegs to the Bunch side with FB, Y and X running patterns toward the side he is rolling to. Z continues straight downfield after his option fake and H can turn his option path into a Wheel route, as well.

The line blocks aggressively, but cannot go more than 2 yards downfield. They should block Inside Zone, waiting for the second level to come to them in response to QB's fake to the F back.

17 DIG

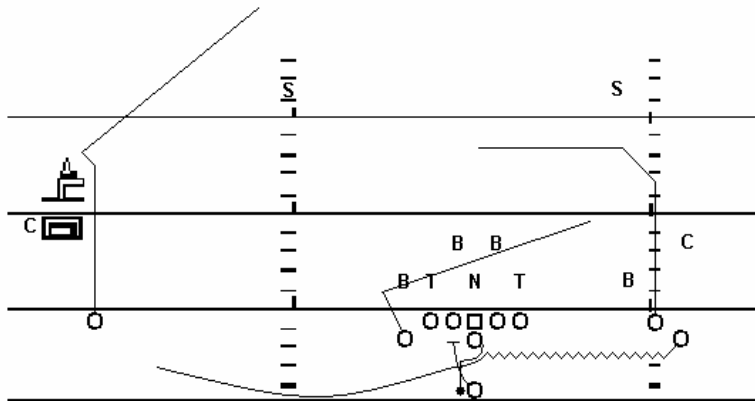

This is a very different play-action complement to 19 Fly Sweep than 18 Boot. X runs a Post, H a Shallow Cross and Y a Dig. Z can either Swing playside or block at the edge. H and Z control the under-coverage, while X keeps the deep safety or safeties honest. Y should gain separation from a man cornerback, or find a zone window to sit down in as he crosses the field. Facing a zone, Y should throttle down to about 75% speed to give him more "loiter time" in the zone windows.

According to Coach Russell Williams,

"We get a pre-snap read to see if the X Post will be open. That is where we want to go first, especially in a short yardage situation."

The easiest (and in my opinion best) way to prioritize this package against zone coverage is to drop down from X to Y, and from him down to H. If needed, you can tag the preferred primary route (i.e. Y Dig, H Cross, etc.) Against man coverage, I would progress straight from X's Post to H's Shallow Cross.

If you are planning on running both 17 Dig and 18 Boot, make sure your QB mixes up his fakes on the 11 Fly Sweep and 14 Dive plays. On some he should boot away from the action, and on others he should drop back to fake a play-action pass.

1X FLOOD

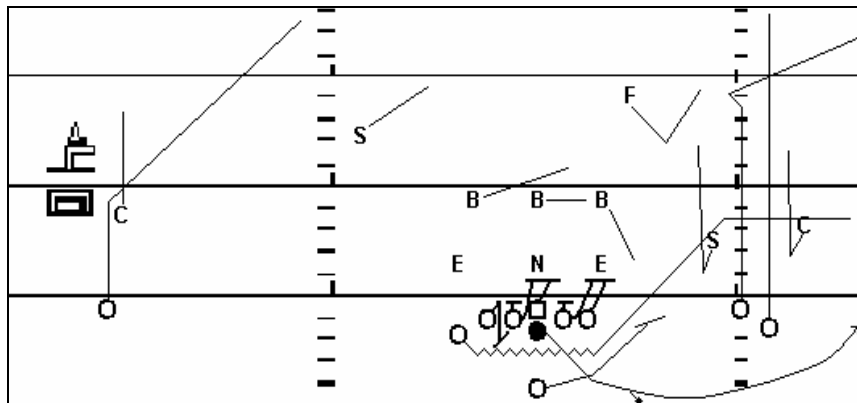

This is a great play-action play, because the run it fakes is itself a misdirection play. 1X Crash (p. 56) makes defenses play honest when H goes in motion past the QB; then 1X Flood makes them pay for their honesty.

QB takes the same angle he does to hand off in 1X Crash, but fakes and rolls past the F back looking for H in the flat. If he sees that all edge defenders have dropped off to cover, he has the choice of running or passing.

Z runs a Go route straight downfield. We want him to take at least one pass defender with him. Y runs with Z for about 7-8 yards, then nods quickly to the Post and breaks out toward the Corner. Against Cover 3 Y will flatten his break slightly to keep his route underneath the C3 corner. Against Cover 2, on the other hand, he will look to split the difference between the C2 corner and the near hash safety. Against any kind of man coverage (C1 or C2/Man Under, which I call C5) Y will accentuate his nod to the Post to pull pass defenders' hips inside with him. H runs a Flat route to about +3-4 yards, whipping his head around sharply to look for the ball as soon as he makes his outside cut. X runs a quick Post, and tries to take two pass defenders with him. He becomes a useful throwback receiver if the defense ignores him.

1X SLAM

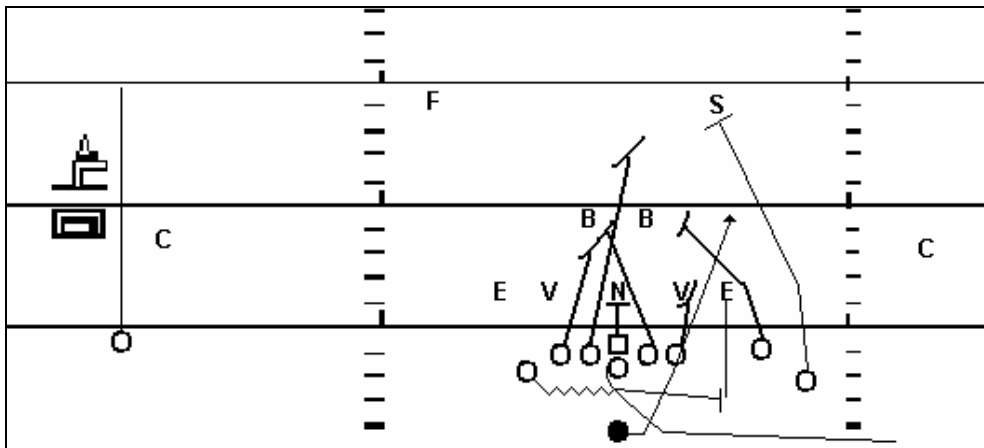

A counter play to 11 Fly Sweep developed by Coach Jim Teahan of Utah. The ball is snapped when H is behind the QB, who reverse pivots and hands the ball to F. H kicks out the playside EMLOS defender, while F carries the ball through the playside C gap, reading Bunch Tackle's block. Both Y and Z look to block inside the C gap to seal it for F. The QB continues outside, setting up the possibility of play-action to Y or Z.

21/29 ROCKET SWEEP

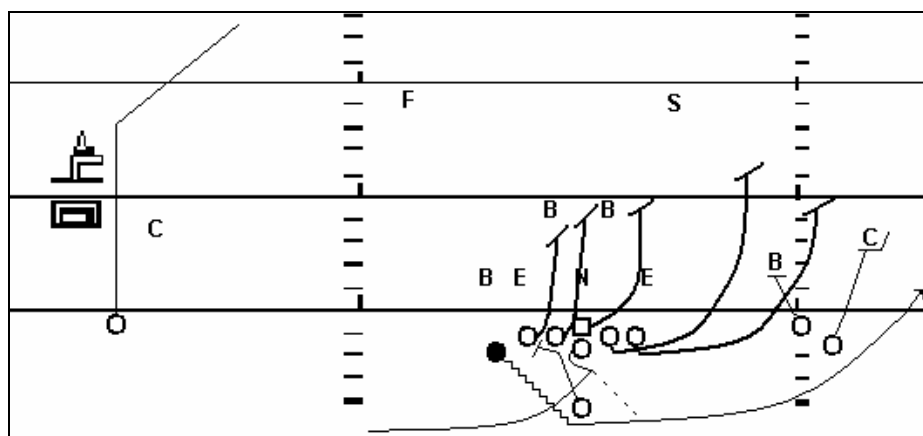

21 ROCKET SWEEP

From the time that my introduction to the Rocket Sweep series in late 2003 delayed the publication of the previous edition of this playbook by several months until today, I have seen nothing to change my mind about the impact this series is having on offensive football. I am still perfectly willing to stick my neck out and call the Rocket the most important offensive innovation of the 21st century.

No one inside the C gap needs to be blocked to make the Rocket soar -- as with the Fly Sweep, the crucial blocks are on the corner. For 21 Rocket, Y and Z must sustain their blocks in order to get H outside and off to the races, but everyone inside Y on the LOS should run their track to the second or third level to cut off pursuit.

H goes in motion to a spot right behind the F back's feet (but moving parallel to the LOS at the snap -- NOT backwards), and will receive the toss from the QB from a spot about 5 yards behind the Bunch Tackle's starting position. He heads for the hash marks, the numbers, and the sideline in a wide arc that will keep him out of reach of most of the defense even if they are completely unblocked. QB reverse pivots, tosses the ball in a soft arc to a spot behind the playside tackle at about chest height, and bootlegs away from motion. The F back blocks the backside EMLOS defender, setting up both the 26 Waggle and the 20 Choice quick passing game. X takes his man (or better yet, men) deep. Y and Z must work hard to impact their defenders and stay with them -- deep release and stalk techniques will not work here.

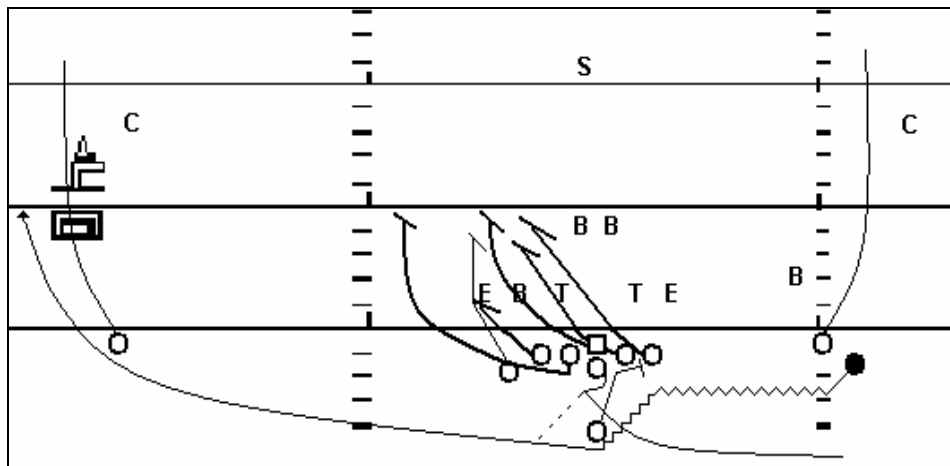

29 ROCKET SWEEP

As with Fly Sweep, we must take advantage of 8-man fronts with the Rocket. Block a wide 8 or 9 technique defender for long enough to get Z around the corner in 29 Rocket, then cut off everyone else from pursuing and let Z run to 1/2 or 2/3 of the width of the field. Once you are past the crush of bodies in the box, the defense gets mighty thin out there in outside deep 1/3 land. X will choose his blocking technique based on the cornerback's pre-snap position -- release deep and stalk if the CB declares deep 1/3 responsibility before the snap; attack and stick with him if the CB presses.

The 21/29 Rocket Sweep and 22/28 Belly Sweep offer the offensive line a choice -- they can block the play (Outside) Zone, TAG (playside Tackle and Guard pulling) or G (playside guard pulling). One or more of these methods will provide an answer to every defensive front you might face. With a variety of blocking techniques to choose from, I think the Rocket series will keep the defense off-balance through multiple misdirection and play-action options. Never forget, however, that all Rocket threats stem from the original back in motion, and its implied assault on the defensive flank.

20 CHOICE

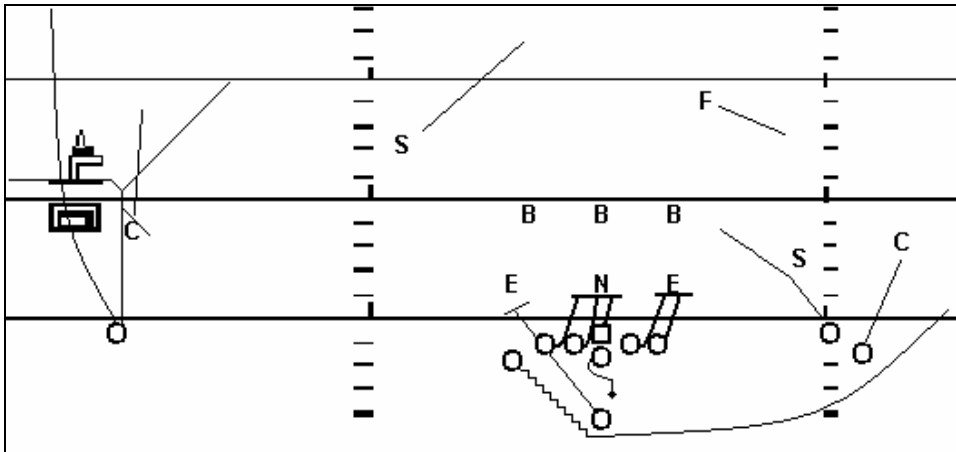

20 Choice is designed to take advantage of defensive over-reaction to Rocket motion -- specifically to secondaries that rotate toward Rocket motion (diagram above). This quick pass resembles the Run and Shoot Choice route package, but is much quicker in execution, which is why I only diagrammed X's possible routes -- there should really not be time to throw to a secondary receiver. The play often develops so quickly when run by Wofford College that the QB only drops one or two steps before firing the ball to the WR.

Conventional Choice theory holds that:

- If the corner plays inside leverage, run a Speed Out at +5 yards;
- if the corner presses, run the Fade route;
- if the corner plays outside leverage, run the 3-step Slant; and
- if the corner maintains more than a 6 yard cushion, run a 3-step Hitch.

The Hitch and Speed Out are particularly popular at Wofford. The Fade takes longer to develop, but is an excellent call if the cornerback sticks tight. I like the quick Slant very much from this action as well.

Routes can either be called in the huddle or signalled between X and the QB -- I favor the latter course, since X will have been studying his man closer than anyone else in the decision-making process. Even if you only run this with the Hitch route, I think you will be pleasantly surprised at how many yards after catch you can achieve for very little effort. The Rocket motion has that much effect on defenses after they have faced it for a while.

26 WAGGLE

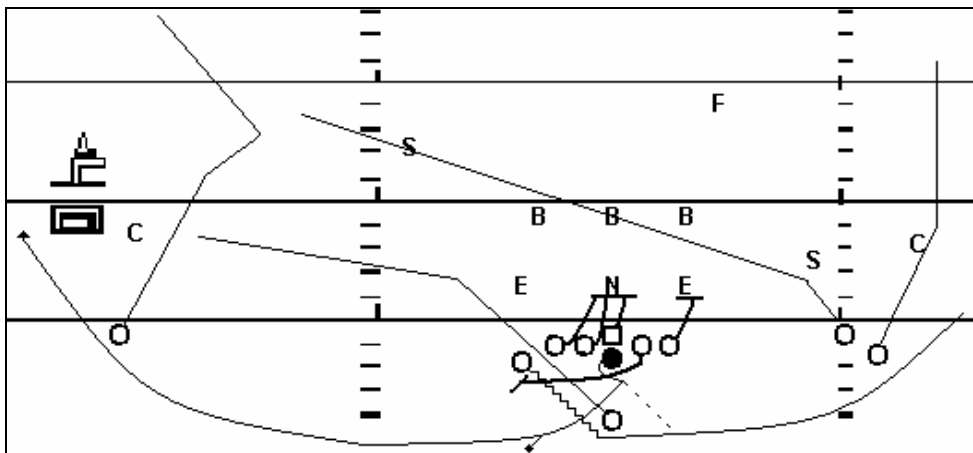

This play takes advantage of defensive preoccupation with both Rocket motion and the 20 Choice play, which can consistently sting secondaries that rotate to Rocket motion before the snap. The blocking action that the F back has been showing in 21 Rocket Sweep and 20 Choice now becomes a misdirection masterpiece, taken directly from the classic Wing-T Waggle play. The F back slips into the flat and looks for the ball immediately -- he is the Q receiver in case the QB feels pressure. X starts off on his lazy Post course just as he does on 21 Rocket Sweep, but then cuts back sharply toward the Corner at about +8 yards. Y runs a Shallow Cross, and offers a mid-level option for the QB. We normally prioritize this shallow to deep for the QB (F, Y, X), but we can change that by game plan. Bunch Guard needs to at least stagger the backside EMLOS defender to make this play work. Never forget, of course, that tucking the ball and running is also an option.

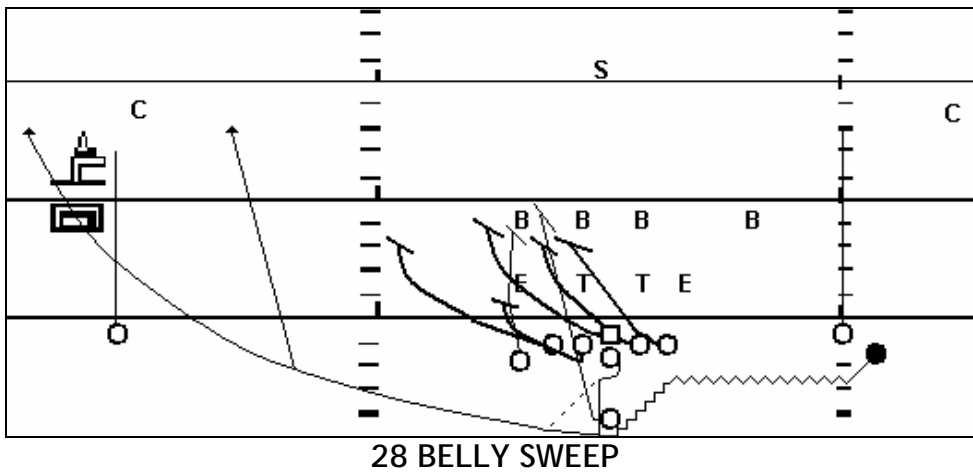

Once again, the theory is to punish the defense for playing an 8-man front against your Wild Bunch attack, with its quick passing and outside running threats. The F back's path will tend to hold inside pursuit, even though the Rocket motion by Z threatens the wide Belly Sweep.

25 BELLY

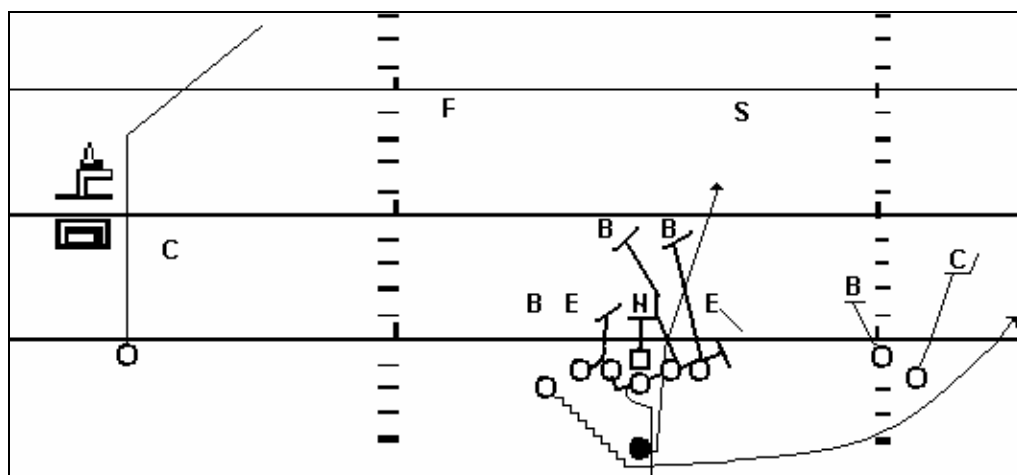

The trap from 22 Belly Sweep action can provide a devastating misdirection blow to defenses that start to over-pursue to the Rocket motion side in anticipation of the Sweep. We use our Gap rules to block 25, (see page 22), but can adjust assignments as necessary against specific fronts. Many of the blocks shown are easier than they might first appear, since the Rocket motion exerts an incredibly strong outside pull on defenses.

After faking the 22 Belly Sweep toss, the QB hands off to the F back and drops down the midline as though to pass. F takes the hand-off and looks for the first daylight he can find off BG's tail. H runs his full 22 Belly Sweep course to mislead as many defenders as possible, for as long as possible.

27 BELLY

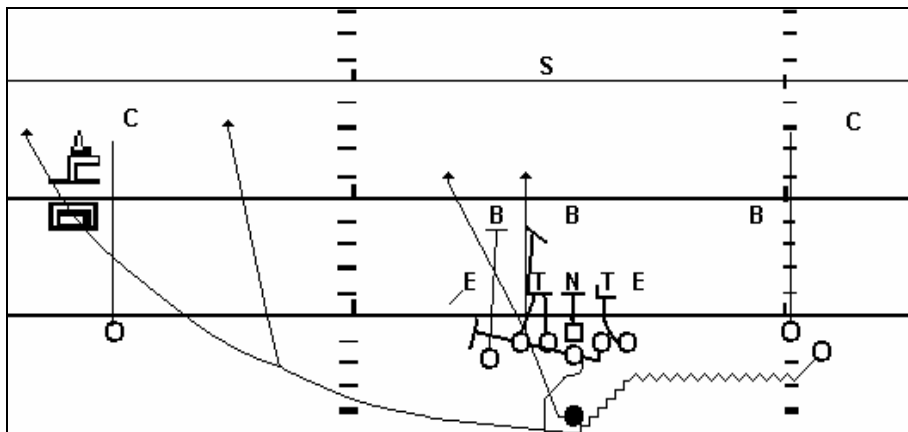

27 Belly offers the same inside misdirection to the F back from 28 Belly Sweep action that 25 does for 22. Although it hits one hole wider, 27 Belly is functionally identical since defenders will be sprinting outside to stop the Sweep toss in any event. We use our Gap rules for 27 Belly (page 22), resulting most often in a kick-out of the EMLOS defender by the pulling BG. F hits a hole wider than he does in 25 Belly, but otherwise follows the same concept -- he looks for the first daylight past ST's tail. The QB's pass fake is integral to holding the whole 28/27/23/24 sequence together as a true series of plays. Similarly, Z should head for his hash/number/sideline landmarks at full speed as though he had the ball every time we run 27.

22 POST

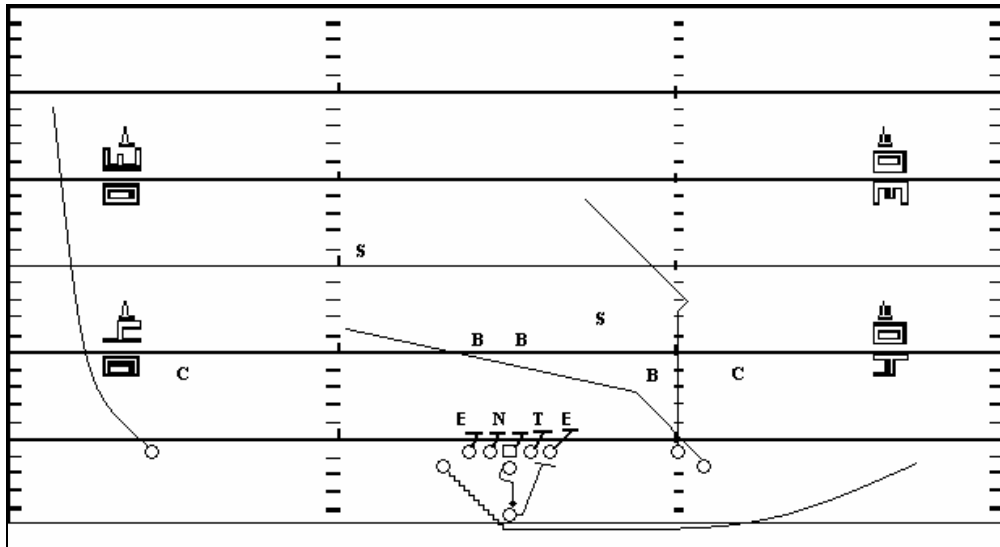

This play action pass off of 22 Belly Sweep action resembles the core play very closely, making it even harder for secondary defenders to cover all the threats. H goes in motion and at the snap sprints for the sideline looking for the ball, just as he does in 22 Belly Sweep. Y and Z head downfield and inside, looking for the first crucial second as though they might be blocking for the Rocket toss.

The QB has a straightforward deep-short progression, from Y's Post to Z's Shallow Cross, and finally out to H's Swing route. H also serves as the Q receiver if protection breaks down and the QB has to get rid of the ball quickly. Thanks to Coach Russell Williams of Temple, Texas for helping me adapt this pass route package to Rocket play-action.

I realize that giving this play-action pass the same number as one version of the core running play (22 Belly Sweep) may cause confusion, but I just plain ran out of numbers. No numbering system is perfect, but this is the only series in my offense where the core running play (21/29 Rocket Sweep - 22/28 Belly Sweep) uses up four numbers, so I can live with this minor conflict.

23 TACKLE TRAP

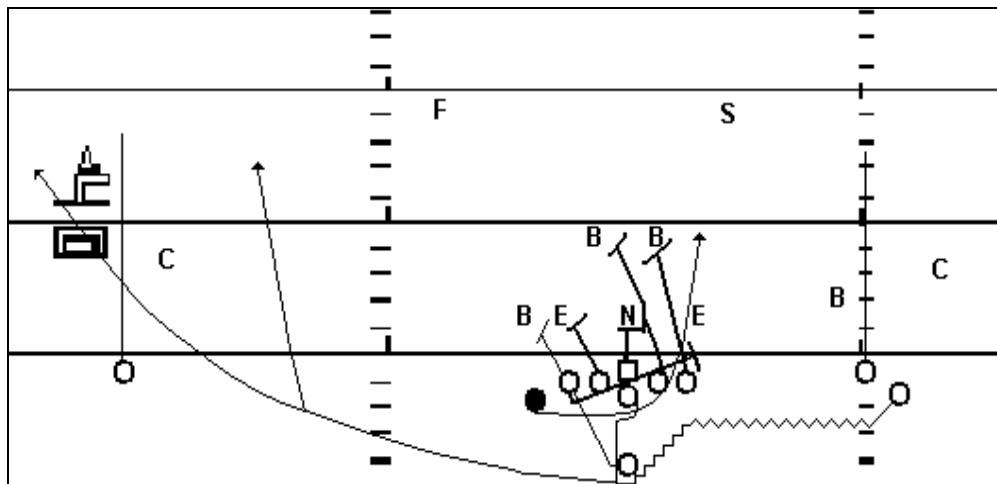

An excellent misdirection play off of 28 Belly Sweep action, Tackle Trap also sets up 24 Sluggo (p. 72), one of my favorite play-action passes. All of the defensive reactions you will see are conditioned by the speed with which the Belly Sweep attacks the defensive perimeter.

This is blocked using our Trap rules (pp. 21-22), except that the Spread Tackle pulls and traps, while Spread Guard blocks G.O.D. H drop steps and heads inside immediately to accept the inside hand-off from the pivoting QB, who should have time to fake the toss before handing the ball off. It is important that the QB drop straight down the midline as though to pass after handing off.

X and Y drive their defenders deep, and Z should run his 28 Belly Sweep course as though his life depends on it.

24 SLUGGO

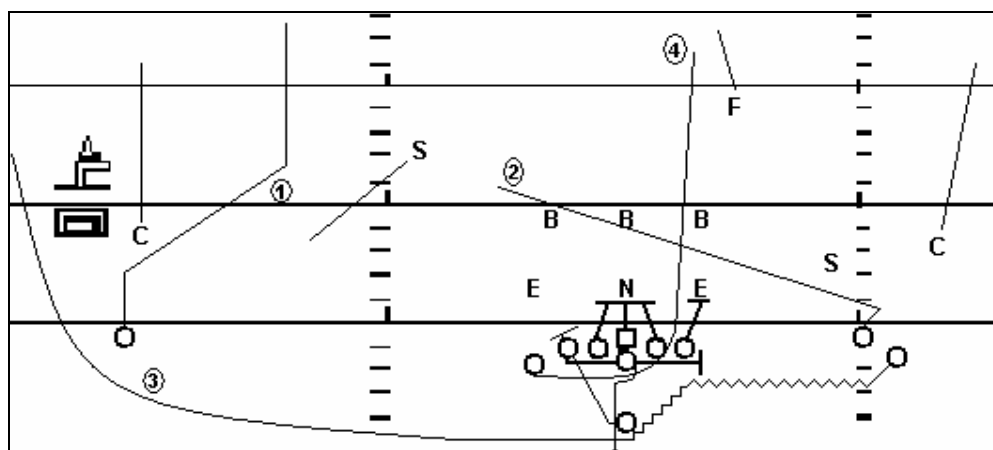

Play-action from the 23 Tackle Trap fake. The QB fakes the toss to Z and hand-off to H, then drops to pass while reading X's Slant cut -- X should come off the ball at 3/4 speed at most, then accelerate the step before he makes his Slant cut. If X is wide open, throw the ball; if you feel pressure from the inside, come across to Y's Shallow Cross; if that isn't open, look for Z's Swing route. X may also come open when he cuts downfield later in his route, which you may want to prioritize against Cover 3 (diagram). H's Wheel route also becomes a throwback possibility.

35 QUICK TRAP

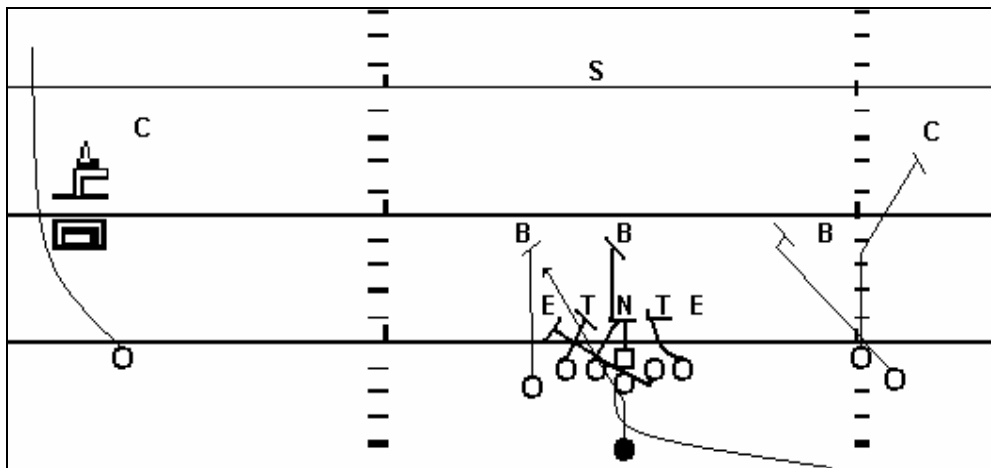

Can be run with or without motion (see page 19). If the EMLOS defender over H pursues his motion across the formation, leaving the next DL inside with contain, we will trap inside him all day long. With motion, also functions as a "Bunch draw." Recently, I have been running this with Z in long motion to the Spread side. For some reason, the threat of "Run and Shoot" pass route packages (our 60 series, p. 98) seems to give defensive coordinators a severe case of sphincter squeeze -- for whatever reason, that threat of R&S Trips to the Spread side of the formation really gets the attention of defenses, and makes running Quick Trap a high-percentage choice. You can run Quick Trap against all defensive fronts with Z in long motion without otherwise changing assignments. (You simply call "35-60" -- see page 19.)

When we find defenses cheating toward Bunch and the field, we will run Quick Trap from the hash without motion. Quick Trap then becomes a great way to pop the F back into the secondary with a full head of steam.

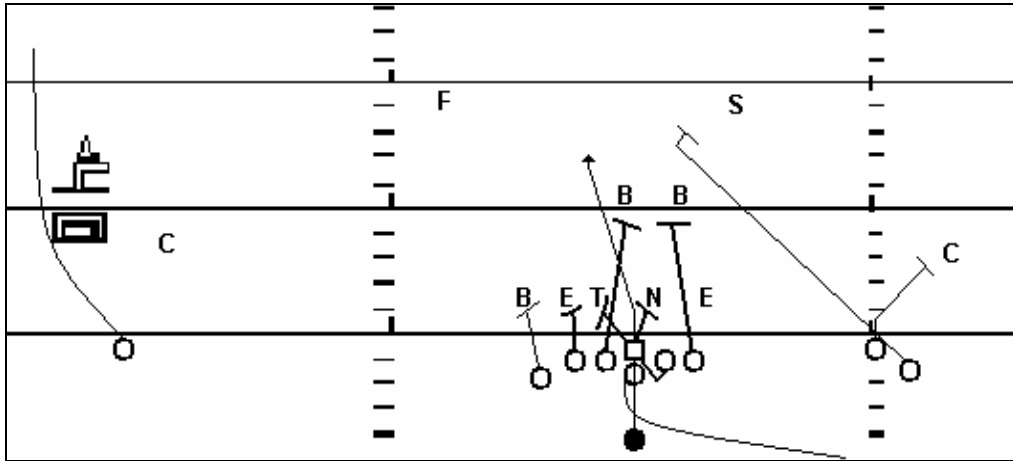

This diagram and the one below illustrate how we like to trap against 4-3 fronts -- always against the 3 technique. No call is needed against the 4-3 Under front illustrated above...

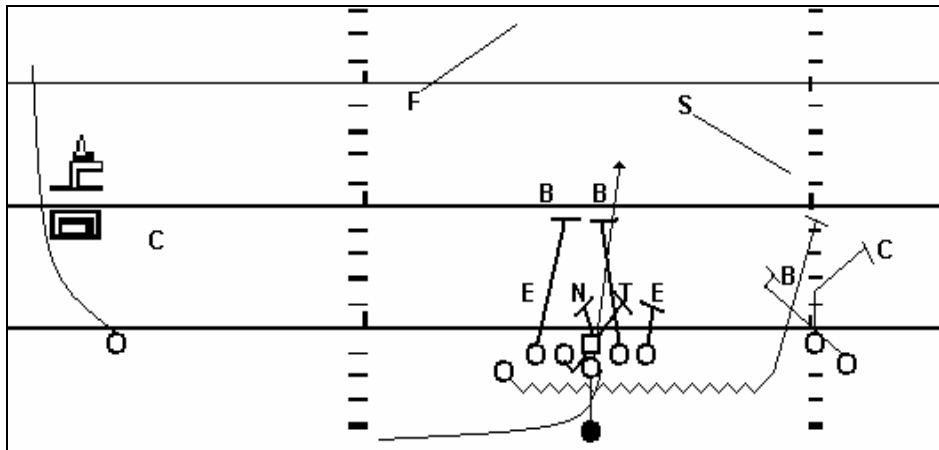

...but against this 4-3 Slide front, the QB would call a designator at the LOS starting with the letter "S" to indicate that the Spread Guard should pull and trap the 3 technique defender lined up over the Bunch Guard. This is a much higher percentage play over time than trying to trap the 1 technique defender.

As far as the QB and F back mechanics go -- the QB always pivots in the direction toward which the guard is pulling. If Spread Guard is pulling to his right from Right formation, for example, the QB pivots to his right and hands the ball to the F back. He vacates the midline to allow the F back to plow straight ahead. The F back then cuts as necessary toward the hole, which is defined as the first daylight inside the trap block.

36 ZONE

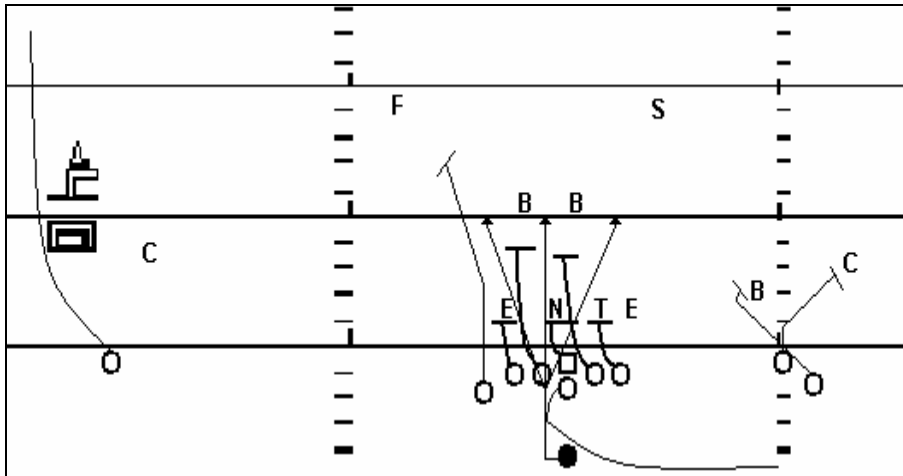

A key to the success of the Inside Zone play is for the F back to take a lateral timing step at the snap, then charge forward, take the hand-off, and run right up on SG's heels before making a decision whether to cut back toward the Bunch side. This is the ONLY cut he is allowed to make. The later he makes his cut, the easier it is for the line to block for him.

To expand on our Zone blocking principles (p 21): This is how we can get a hat on each defender from a slotback one-back formation. Notice we spread our formation to keep the seventh defender out of the box.

All OL's take an initial short playside step at a 45 degree angle to the LOS. If an OL is covered, he blocks the man on with the outside earhole as his aiming point. If uncovered, he will double playside with the covered OL. At this point they will stay engaged with the double team until they reach the second level or the second level comes to them. Their concept is "Four hands on the Lineman, Four Eyes on the Linebacker." If the DL slants one way or another, the OL he slants away from will come off on the LB. If he tries to stand his ground, the two OL's will push him back into the path of the LB. In the event that the uncovered lineman has no one to double team, he will work to the second level with his shoulders parallel to the LOS. We work hard to distort the defense with the double team so that the F back may have a cutback lane.

If the defense insists on keeping seven in the box, we can still run the play -- the QB becomes responsible for controlling the backside EMLOS defender with his bootleg (as he does against the 6th defender in the 4-3 front above).

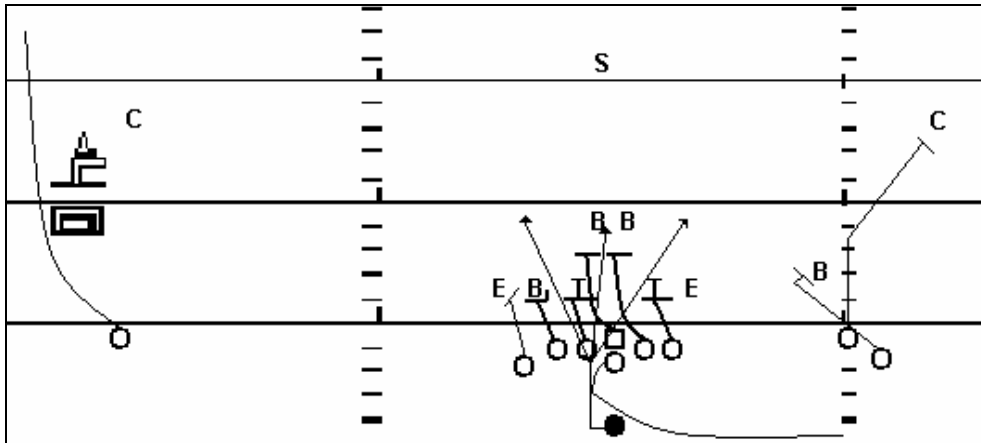

"Where there are no linebackers, there is no zone play." Homer Smith has spoken. Where there are linebackers, however, such as in the Split-4 front diagrammed above, there are two offensive linemen stepping through their tracks to block them. The Center may bypass the 3 technique aligned over Spread Guard if he shoots the B gap -- he becomes SG's problem at that point, and the Center tracks downfield with shoulders square to the LOS to find the nearest wrong-colored shirt. If he pressures inside at all, however, the Center and SG will probably end up double-teaming him until one of them comes off for the second-level defender. The F back's cut to the Bunch side becomes quite likely against this defensive front. Again, this is the ONLY cut F is allowed to make on this play. Run up to SG's heels, make one cut or plow straight ahead -- that's it. I believe this is a reason for much of the success Cory Dillon had running the Inside Zone play for the New England Patriots.

34 COUNTER

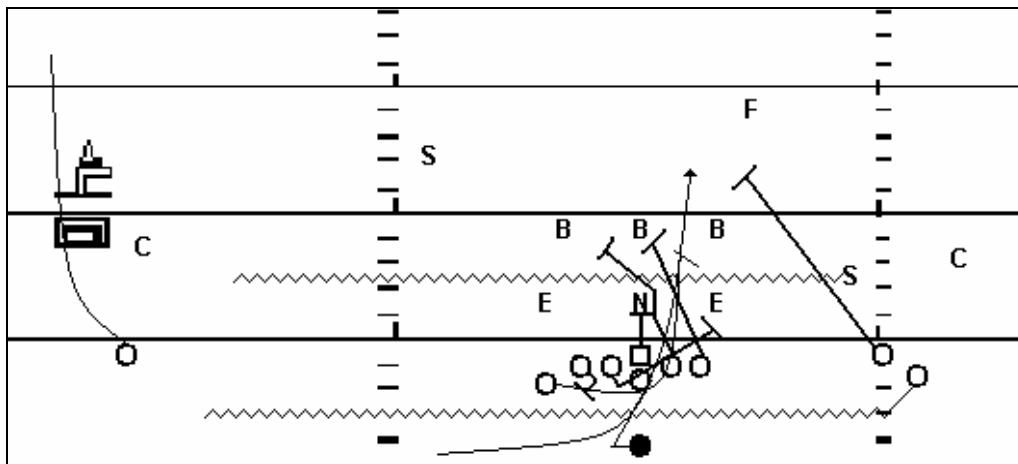

FB's lateral step resembles 36 Zone, but he cuts back and follows Spread Guard and H through the hole. Bunch side of the line seals to the inside, SG kicks out the Bunch-side EMLOS defender, ST hinge blocks (like backside SPRINT pass protection) to pick up a crashing or slanting defender, while H pulls through the hole and walls off pursuit.

As diagrammed above, we can motion Z across the formation to threaten our 60 passing series -- there is just something about the words "Run and Shoot" that grab the attention of defensive coordinators. We take advantage of this phenomenon whenever we can to increase our misdirection capabilities at no extra cost to us by calling "34-60" in the huddle (page 19).

From the Swap formation adjustment (page 15, top diagrams), we can also motion H to form the Bunch, then still run 34 Counter by having Y pull and wall off in H's place.

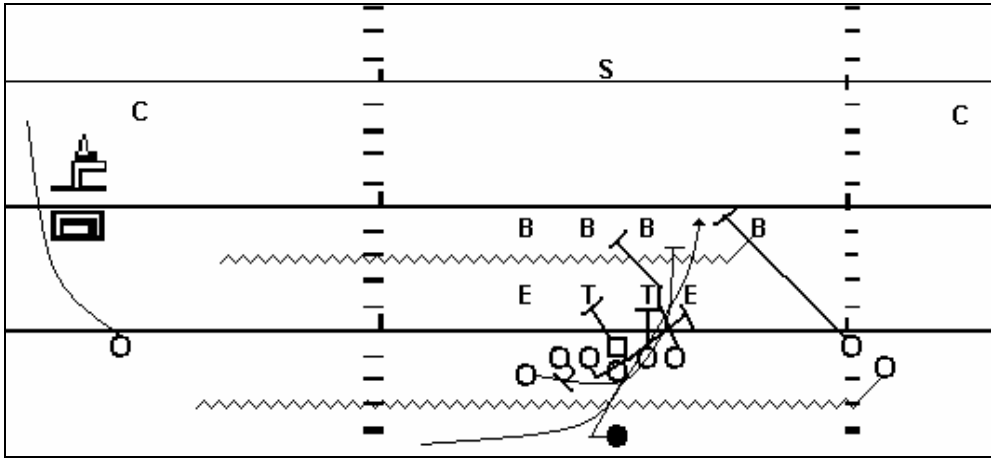

Both the long motion by Z ("34-60" - see p. 19) and the initial jab step by F will help encourage the linebackers in the 4-4 Stack diagrammed above to move away from our actual POA. If the playside ILB hangs tough, H still has a shot at sealing him off long enough to get F downfield with the ball.

30 OVER

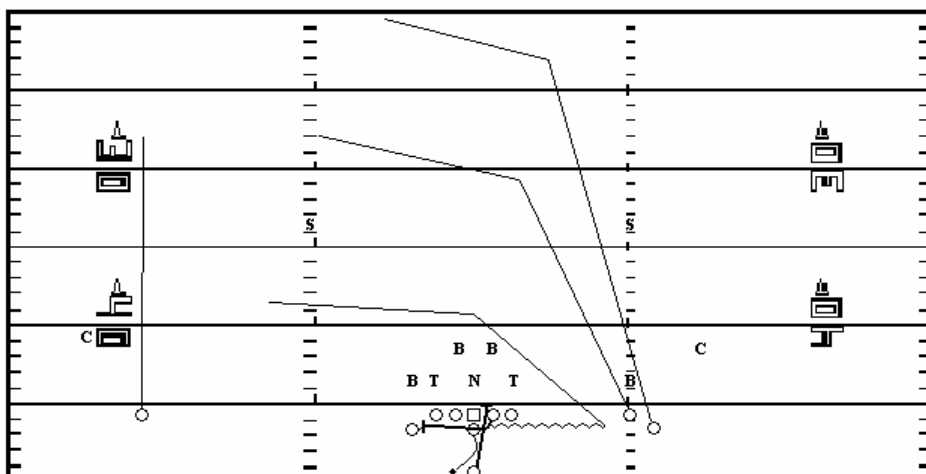

Play action off the powerful 35 Quick Trap fake, combined with a backside attack against over-adjustment to Bunch. H goes in motion then Crosses to +6, Y reaches +14 over the Bunch Guard, then flattens, while Z flattens at +22. X flies down the numbers, not even looking for the ball unless he runs by his man. QB looks off Z's Climb for the first few steps of his drop, and then sets to throw while looking for Y's Over. If the LBs don't bite on the play fake and drop quickly (this rarely happens), QB throws to H's Shallow Cross right now to give him a good yards after catch possibility. Against man coverage, hit the receivers in stride for maximum yardage potential. FB fills for the Bunch Guard, who pulls and kicks out the playside OLB if he rushes.

The combination of the Over route package and the Quick Trap fake gives us a potent weapon, especially on first down. With the LB's reacting up to the fake, we give H more room to run his Cross. Against C3, the safety may jump Y's Over, giving QB a shot at hitting Z's Climb -- but only if he has an absolutely clear read.

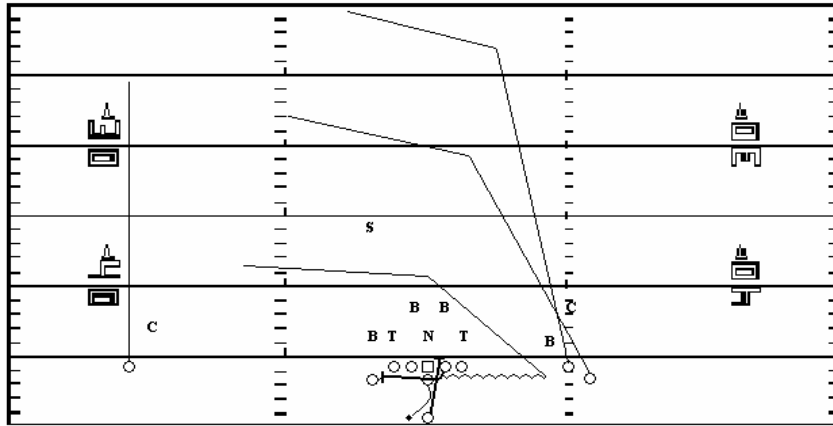

Against man coverage, we switch Y and Z's assignments to create a rub right past the LOS and pop one of them open quickly -- usually Z's Over route. QB can throw it almost like a quick Slant if he sees Z come open off the rub -- Z should be ready to receive the ball right away. If there is no quick throw, Z becomes the "object receiver" whom the QB reads to discern the coverage. Throwing to the open man becomes a reflex.

Versus Cover 4, we like Y's chances running his Over against the Bunch-side safety. H may also pop open over the middle if FB runs a convincing Trap fake. Y and Z can both break a big play against this coverage if the Bunch-side safety and corner don't get inside help deep. Focus on the middle route by Y. If a safety drops down from above him to cover, Z will be open. If a LB drifts back to cover Y, H will be open. Focus on Y as you drop back, then react to coverage -- if no one drops down or drifts back, of course, throw it to Y!

32 QB WEDGE

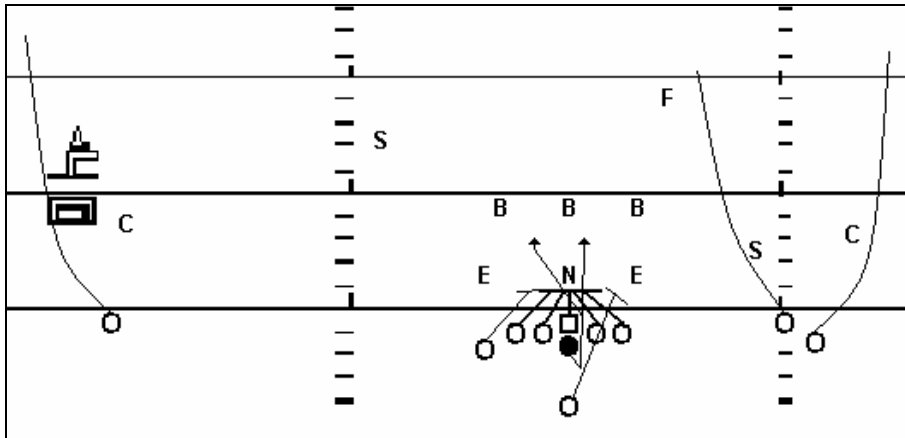

A sure gainer if practiced properly. We use a delayed wedge as our QB sneak play, and it is a very common audible (see top of page 19). As the line surges forward to interlock shoulders behind and underneath the Center's pads (no matter what the front, we always wedge over Center), the QB takes a short timing step (which should resemble the first step in his 3-step pass drop), then surges forward with shoulders low but eyes up, looking for a crease in the wedge to squeeze through for the first down or touchdown.

Note: I do NOT recommend having your QB dive over the line under any circumstances. If that is our only hope of scoring, I would rather lose the game than risk the physical safety of my QB.

33 QB DRAW

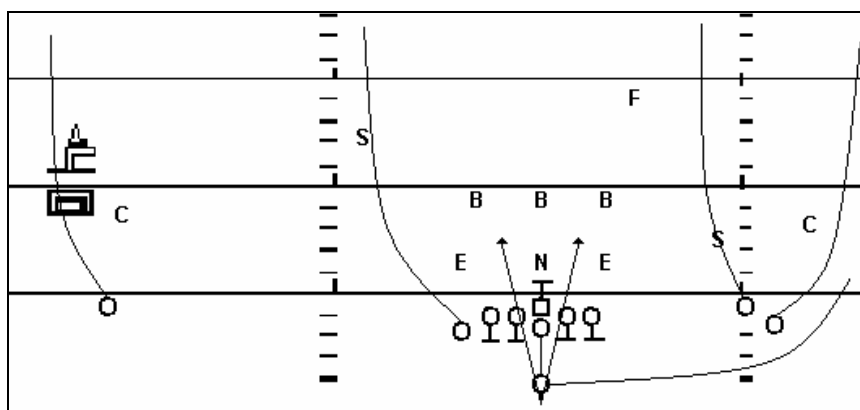

When pass rushers start to get sloppy and lose their lane discipline, 33 Draw can really sting them for some "bonus yards". The QB will drop as he normally would on a five-step pass. On his third step, however, he will drop his hips to come under control, roll forward, and look for daylight among his offensive linemen.

The line sets for BOB pass protection, and will ride pass rushers in the general direction they want to go -- if a DT tries to bull-rush BG right toward the QB, for example, he will use the defender's momentum to run him right past the pocket.

While we show the receivers running 50 Seam routes (p. 91), any pass route package that threatens the vertical shot will work.

39 BOOT

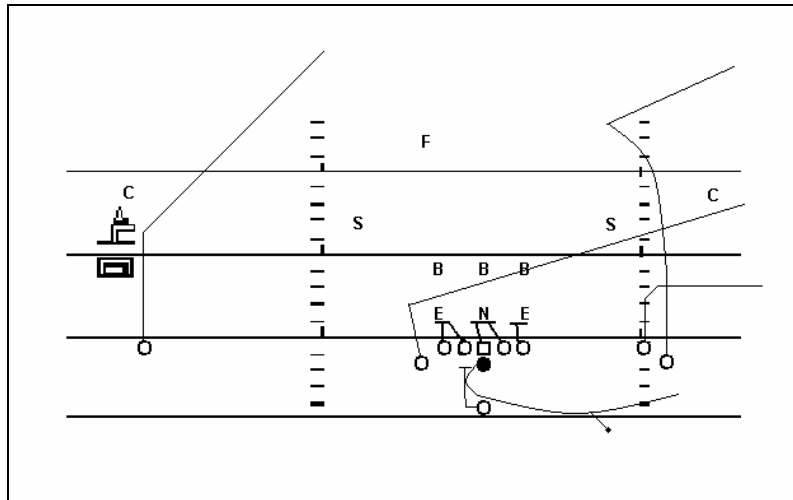

The bootleg off our 36 (Inside) Zone play -- we sometimes run this one 4 or 5 times a game. F and the QB make a credible 36 Zone fake, after which F blocks and the QB bootlegs to Bunch. X runs a quick Post, H a Shallow Cross, Y a Speed Out, and Z a sort of Sail/Corner route, bending in toward the Post before cutting sharply back out toward the Flag at about +13 yards. QB's read progression will depend on our game plan, but usually starts with Y (Coverdale's Law: never bypass an open receiver). Given the timing of H and Z's routes, sequencing the reads from short to long (Y, H, Z) is, for once, not a bad idea, with X available as a "transcontinental" throwback receiver if your QB can make that throw.

Running the ball in 39 Boot is definitely an option worth emphasizing, especially if you only need short yardage and your QB is quick enough to step out of bounds just past the first down marker. Note: You can turn this into 39 Waggle by pulling the Spread Guard and having him lead for the QB -- the F back then fills for the pulling Guard.

37 LEAD

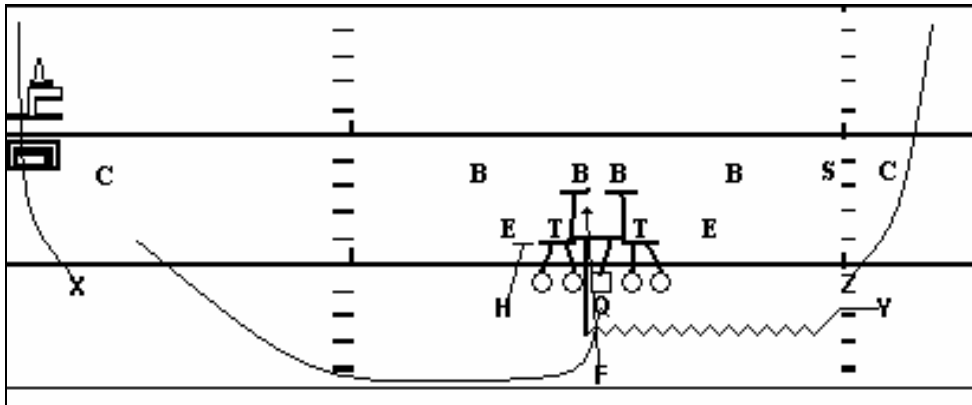

A special goal line and short yardage play where we can swap Y and Z, send Y in motion as though to receive a 60 series pass or run the 19 Fly Sweep, then have him lead through the 6 hole (Spread-side A gap) for F. QB snaps the ball when he feels Y tap his butt, open pivots, hands to F, and sprints outside with his hands hidden on his far hip. F runs in low and hard behind Y, SG and Center. We can either block this Zone or Wedge depending on the situation. An excellent play-pass is possible off this action, especially if defenses start keying the Y/Z position swap. Of course, you can also run this with Z leading for F, if you have the right personnel in place.

38 ICE

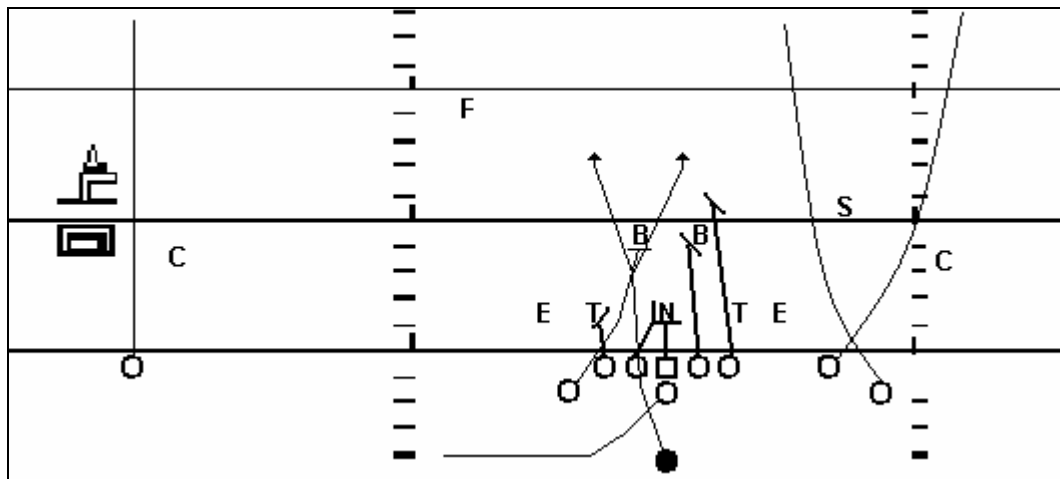

This play allows us to run with power over the Spread Guard by bringing H down on the defender over that Guard. It will typically be used against an odd front, especially a 3-5-3, 3-4 or 5-2 look.

An especially useful variation is to send Z in "60" motion (by calling "38-60," p. 19) and then snap the ball when he is out wide near X, just as we do for 60 Short (p. 98). This exerts a powerful pull on the Spread-side safety, and often means that if we can pop F past the LOS on this play, we can make big yards.

50 - 80 SERIES: THE PASSING PLAYS:

The passing game of the Wild Bunch is simple but powerful. I have tried to distill the best features of the Run and Shoot, Bunch Attack, and Air Raid offenses into the Wild Bunch passing attack in a way that best fits in with the formula "Simplicity Times Deception" (p. 11).

Although the plays remain broken out by series, in a way which is usually characterized by the kind of motion (if any) used to run that particular pass route package, screen pass or pass-action run, I am also introducing in this version of the book the concepts of horizontal stretch, vertical stretch, and man-beater packages. Against any given opponent, I would expect coaches to prepare a small number of each type of pass to have ready for that game. See page 90, as well as the diagrams which follow, for examples of each concept in action.

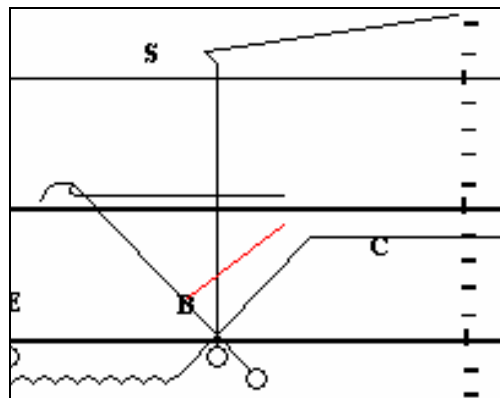

HORIZONTAL STRETCH

This places the pass defender in a bind with receivers to his right and left. The QB looks to one receiver and, if the defender reads his eyes and moves to cover that man, he throws to the other receiver. The example shows Z's Whip Read and H's Flat routes from 74 Mesh (p. 110).

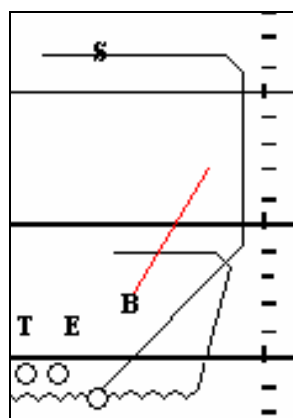

VERTICAL STRETCH

Here the bracketing of the defender happens high and low. H's route will place him above the drop of the Will backer, and Z's will come underneath him (from 65 In, p. 103).

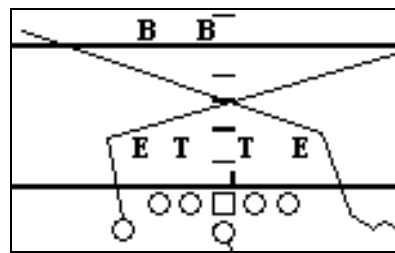

BEATING MAN COVERAGE

This concept is very simple -- crossing routes lead to natural rubs as receivers brush shoulder pads. This example is from 62 Flag (p. 100), and demonstrates how hard it is to play tight man defense on H and Z as they mesh together a few yards downfield.

Some coaches recognize another concept -- the oblique or diagonal stretch. Coach Norm Chow is a big believer in this, which forms the basis of his "triangle reads" (see 51 Y Cross, p. 93, for a classic example). I tend to believe that the triangle is powerful because it combines elements of both horizontal and vertical stretches, not because it exemplifies a separate idea, the oblique/diagonal stretch.

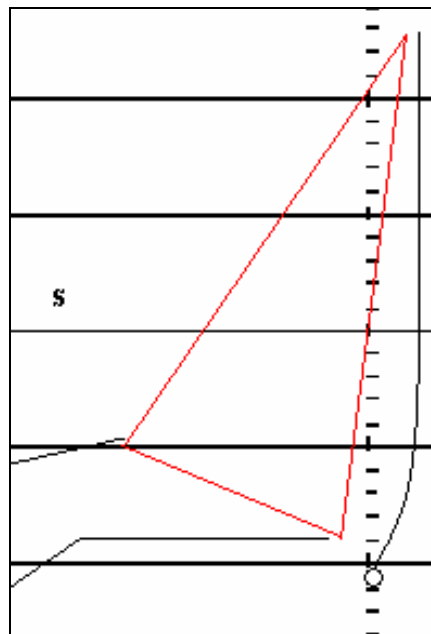

OBLIQUE STRETCH

Finally, the 80 "series" is actually the most convenient place to group two kinds of plays -- those using the STACK formation (80-84), and those employing MAX pass protection from the SWAP formation variant (87-89).

I also want to demonstrate what the defense sees when certain Bunch route packages are run. These homologous* packages present special problems for defenses due both to the proximity of the Bunched receivers, and to the way the different pass routes fit together. This, for example, is what the defense sees when we run 74 Mesh (p. 110).

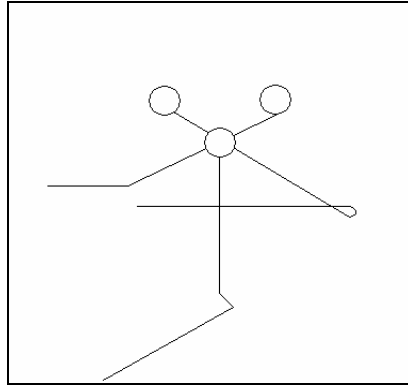

Here is the defensive view of 70 Arrow (p. 106).

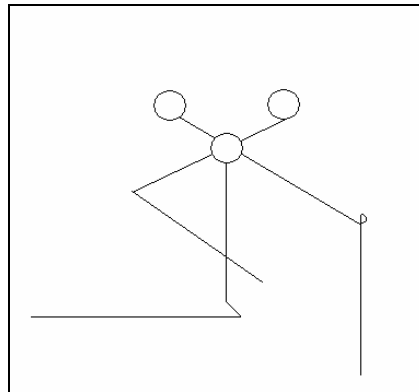

And this is the defense-eye-view of 75 Shallow (p. 112).

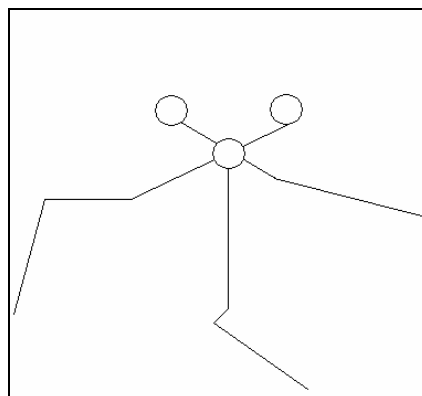

As you can see, the three plays together present a difficult challenge to defenses, especially those which count on pattern-reading principles to help them eliminate offensive possibilities so they can focus on high-probability offensive maneuvers. With the "unholy three" (plus 78 Quick, p. 115) we remove that tool from the defensive arsenal.

*Homologous: Corresponding or similar, especially in structure.

| <u>SERIES/PLAY</u> | <u>PAGE</u> |
|-----------------------------|-------------|
| <u>50 NO MOTION:</u> | |
| 50 Seam [^] | 91 |
| 51 Y Cross [^] | 93 |
| 52 Smash [^] | 94 |
| 56 Screen | 96 |
| 58 Statue [^] | 97 |
| | |
| <u>60 MOTION TO SPREAD:</u> | |
| 60 Short [†] | 98 |
| 62 Flag | 100 |
| 63 Go [†] | 101 |
| 64 Out | 102 |
| 65 In | 103 |
| 66 Ram | 104 |
| 68 Draw [†] | 105 |
| | |
| <u>70 MOTION TO BUNCH:</u> | |
| 70 Arrow [*] | 106 |
| 71 Niner | 107 |
| 72 Deuce | 108 |
| 73 Go | 109 |
| 74 Mesh [*] | 110 |
| 74 Option Screen | 111 |
| 75 Shallow [*] | 112 |
| 76 Switch | 113 |
| 77 Curl-Flat | 114 |
| 78 Quick [*] | 115 |
| 79 Turn | 116 |
| | |
| <u>80 STACK AND MAX:</u> | |
| 80 Now | 118 |
| 81 Now Screen | 119 |
| 82 Slant-Fade | 120 |
| 83 Drive | 121 |
| 84 Bubble | 122 |
| 87 MAX Hinge | 123 |
| 88 MAX Twist | 124 |
| 89 MAX Wrap | 125 |

^{*}, [^], [†] - Homologous plays

WILD BUNCH: BREAKDOWN OF 50-80 SERIES

| <u>HORIZONTAL STRETCH</u> | <u>PAGE</u> | <u>VERTICAL STRETCH</u> | <u>PAGE</u> | <u>MAN-BEATER</u> | <u>PAGE</u> | <u>PASS-ACTION RUN/SCREEN</u> | <u>PAGE</u> |
|---------------------------|-------------|-------------------------|-------------|-------------------|-------------|-------------------------------|-------------|
| 50 Seam [^] | 91 | 51 Y Cross [^] | 93 | 62 Flag | 100 | 56 Screen | 96 |
| 60 Short [†] | 98 | 52 Smash [^] | 94 | 64 Out | 102 | 58 Statue [^] | 97 |
| 63 Go [†] | 101 | 65 In | 103 | 66 Ram | 104 | 68 Draw [†] | 105 |
| 70 Arrow [*] | 106 | 77 Curl-Flat | 114 | 71 Niner | 107 | 74 Option Screen | 111 |
| 73 Go | 109 | 78 Quick [*] | 115 | 82 Slant-Fade | 120 | 81 Now Screen | 119 |
| 74 Mesh [*] | 110 | | | 83 Drive | 121 | 84 Bubble | 122 |
| 75 Shallow [*] | 112 | | | 87-89 MAX | 123-125 | | |
| 79 Turn | 116 | | | | | | |

[^]/[†]/^{*} Homologous plays (60 Short and 63 Go are homologous with 68 Draw, but not with each other)

50 SEAM

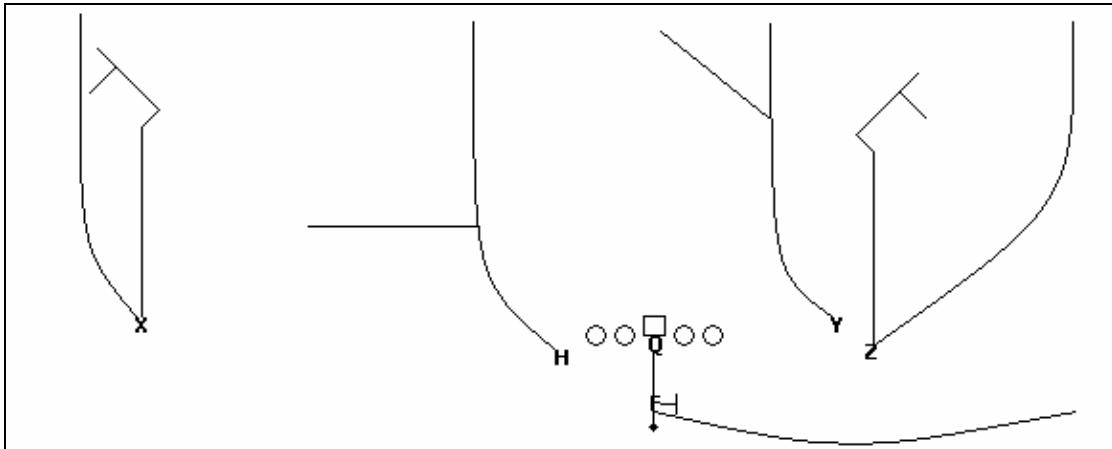

This pass route package has been significantly transformed from earlier versions I have used. It is now adaptable to different coverages based on a simple pre-snap/post-snap read process. The package converts automatically from four verticals against Cover 3 or Cover 1 to three verticals against Cover 0, 2, 2-Man Under (Cover 5), or 4. See pp. 38-45 on QB reads.

Pre-Snap Read: The QB will look to the middle of the field, as will X, H, Y and Z to see if there is a safety in the middle of the field or not (see page 38 for the MOFO/MOFC distinction). Routes are adjusted as follows:

Middle of the Field Closed (MOFC - Cover 1 or 3):

- X: Outside Vertical route up the top of the numbers
- H: Outside Vertical route up the hashmarks
- Y: Inside Vertical release up the hashmarks
- Z: Outside Vertical release toward the tops of the numbers

Middle of the Field Open (MOFO - Cover 0/2/4/5)

- X: Corner/Comeback route
- H: Outside Vertical release, breaking Out at +7 yards
- Y: Inside Vertical release, breaking to Post at +12 yards
- Z: Corner/Comeback route

For the best description of the Corner/Comeback route I have seen, I turn yet again to Chris Brown and his superior Smart Football blog (<http://smartfootball.blogspot.com>):

Beginning with the outside foot back, he will release vertical for 7 steps and should reach at least 10-12 yards. He will plant on his outside foot and break at a 45 degree angle to the Post for three steps, looking back at the QB on the second. On his third step he will plant his inside foot hard, open his hips and break for the corner at a hard 45 degree angle. If the cornerback stays inside he will break hard for the near pylon. If the corner stays outside or quickly is back over the top of him, he will drive his outside elbow and plant his outside foot flat to the LOS, and begin to come back for the football. If this happens he will catch it at 18-22 yards (this requires QBs without strong arms to have great timing).

The F back will, in all cases, check his blocking assignments and then release into a Swing route toward the Bunch side. He serves as a Q receiver in case of early pressure which requires a quick dump-off by the QB.

With a pre-snap MOFC read, the QB will drop with an eye on the safety. If the safety remains in the middle of the field, the QB will eyeball one of his two inside receivers (H and Y) and then, if and when the safety breaks on him, throw to the other.

With a MOFO read, he will look for the Bunch-side safety. If he is low or missing entirely (i.e., down at LB depth or even tighter to the LOS), it's Cover 0 and H's 7-yard Out is your best bet to beat the blitz (if Y is astute enough to spot the blitz potential, he may look for the ball quickly as well). If that safety drops toward his Cover 2 half-field responsibilities, look for Y's Post to find the deep middle hole, and from there look to Z toward the deep Corner. Finally, if the Bunch-side safety drops down to the hole in the middle of the field, or takes off for the outside third, it is a disguised Cover 3 -- either C2-Robber or C2-Tampa. In that case, you want your best match-ups against their defenders -- I would look for X's Corner/Cutback and then H's Out.

51 Y CROSS

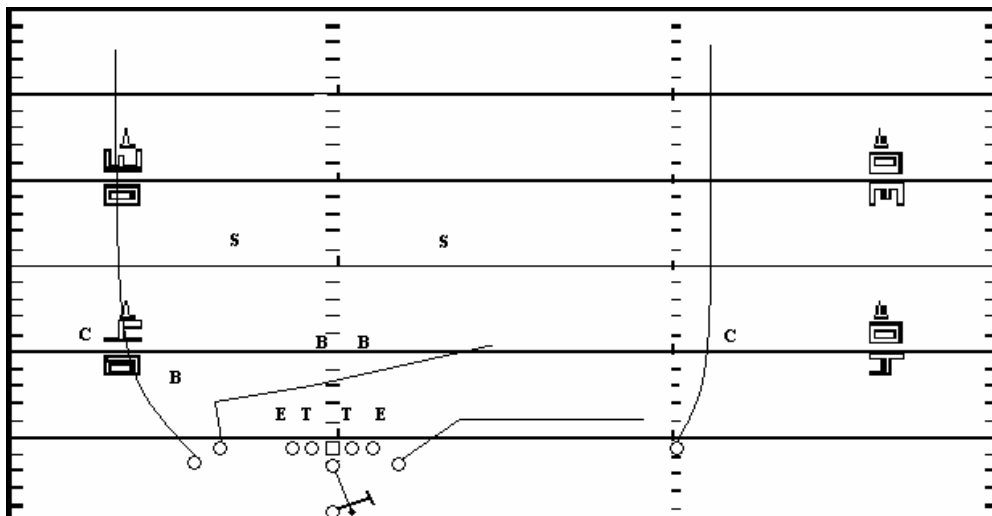

This is a simple yet effective triangle read with X going deep on an Outside Vertical release, H running a very quick Shoot route at +1 yard, and Y running a Shallow Cross that will put him no more than 5 yards deep when he passes H's original position. You can decide how you want to prioritize the reads. As Coach Bill Mountjoy has often pointed out, the human eye refocuses much more quickly and easily deep-to-shallow than it does shallow-to-deep. That said, you may want to take the easy yards out in the flat if the defense is giving them to you. Y coming across the formation late provides a third option who is very, very hard to cover consistently. Coverages which over-compensate toward the Spread side against packages like this can leave Z wide open deep, as well.

52 SMASH

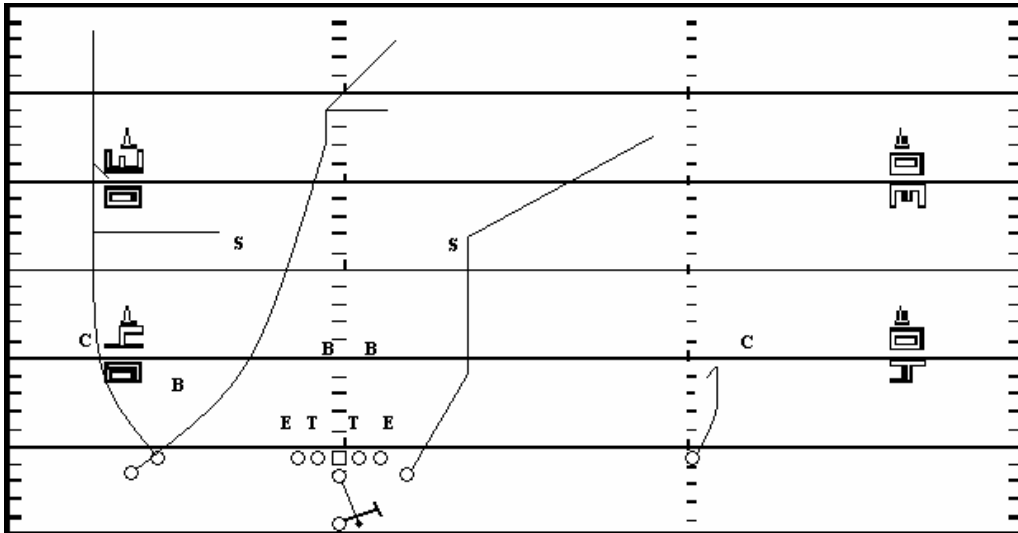

I have done away with the older version of this route package where receivers ran different routes based on coverage. Instead, I now have two ways of running the package. This play is designed for use against Cover 2, but we do sometimes run into surprises when we reach the LOS. The two variations give us different ways to cope with those surprises.

Smash: X runs a 5-yard Hitch in both variations, just as he did in the original package. H runs a Corner route against all coverages. Y and Z use a variation of the "Switch" package from the Mouse Davis Run and Shoot attack, with Y taking an Outside Vertical release and Z an Inside Vertical release. If Y's defender is still over the top when he hits +10 yards, he breaks In at about +12. Z has a deep Middle Read that will cause him to break to the Post at about +18 if there is no safety in the deep middle, and across the field on a deep In if the middle of the field is closed.

With a MOFO read before the snap (p. 38), the QB will look to the Spread-side Corner for his read. If he presses or hangs in place, look for H's Corner route; if he bails, throw X's Hitch. With a MOFC read, he will instead read the safety. If he stays in the deep middle, look for Z and then Y (both of whom should break their routes off to Ins at different depths). If he rolls to a C2 hash safety position, look for Z to the Post and then Y up the sideline.

This version of Smash is what Coverdale and Robinson call a "packaged sides" route combination -- the QB knows to look to the Spread side of the formation against Cover 2, and to the Bunch side against Cover 3.

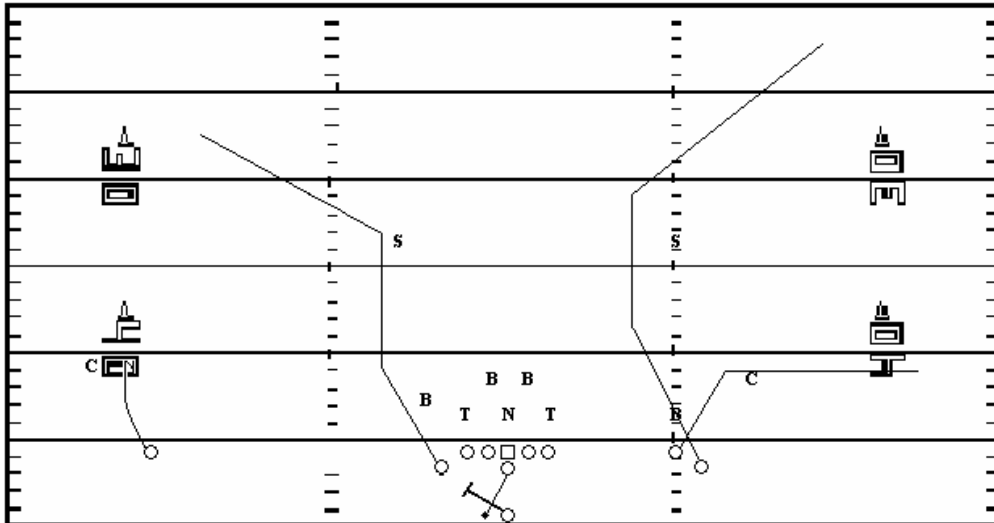

Special: We will run "Smash Special" against teams that prefer to use man coverage. In this version, X and H run their same Hitch-Corner package to the Spread side of the formation, but Y and Z now run a different set of routes. Smash Special is also a "packaged sides" combination, with the QB looking to the Spread side against zone coverage, and to the Bunch side against man coverage. If the defense unexpectedly shows Cover 3, the QB can audible to another package, or else he can pick which side has poorer flat coverage, then throw to X or Y, respectively.

Against man coverage, the QB will focus on Y's quick Out first, then Z's Corner route. The natural rub from Z should help Y get quick separation from a pure man defender. (If the defense is banjoing, we will look at motioning to Bunch and throwing different pass route packages at them.) Z should look for the ball after he clears the rub with Y -- in case of a coverage breakdown, he can rack up some serious yards on what amounts to a quick Slant in the first portion of his route.

56 SCREEN

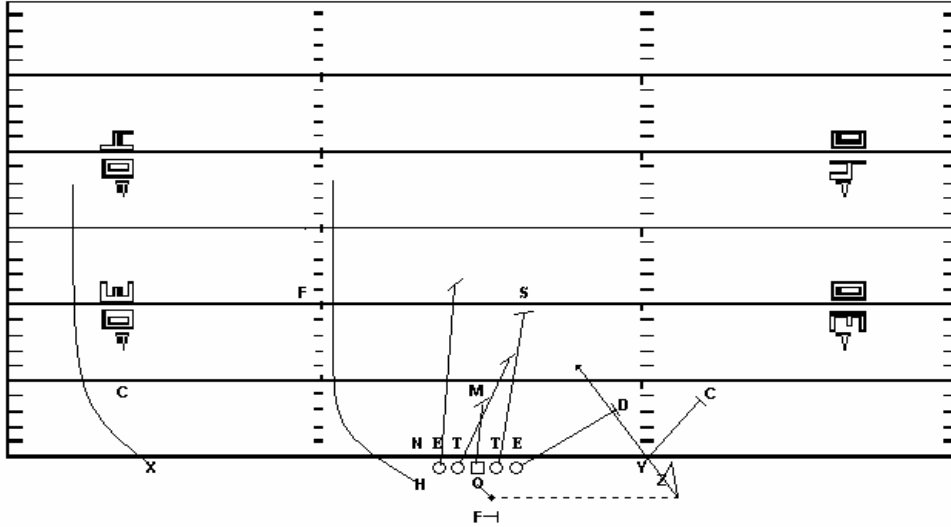

This gives us a good answer to an over-enthusiastic pass rush. X and H run Seam routes, trying to clear as much backside coverage with them as possible. The line (except for Bunch Tackle) releases immediately for the nearest LB; if someone else already has him, continue downfield for the next wrong-color jersey. Bunch Tackle attacks the defender over Y, while Y blocks the man over Z. Z takes an outside diagonal step with his inside foot, then pivots and drops back to face the QB. QB throws the ball at about 60% speed as soon as he has it under control -- this is a "half-step" drop, with QB opening up with his Bunch-side foot pointing right at Z, and gets the ball to him right now. Z gathers the ball in and cuts inside BT's block, then looks downfield for maximum daylight. FB steps playside, but isn't involved in the play. We have a companion fake-screen-and-Go play, where QB first fakes the screen and then drops back to pass, but we only use it after we've hit the screen at least twice. Also very effective from STACK (p. 16).

58 STATUE

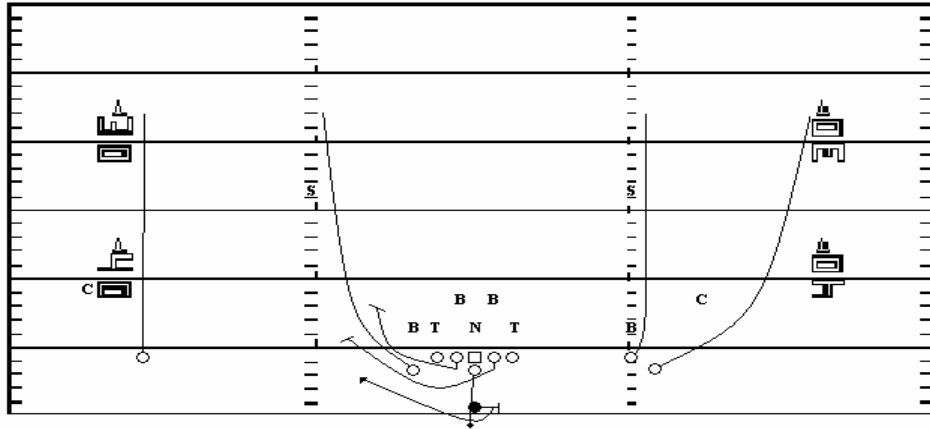

This play takes advantage of over-enthusiastic pass drops by the underneath coverage combined with ears-back pass rushing -- very useful against Cover 5 (Cover 2/Man Under) in particular.

Guards pass-drop facing slightly toward Bunch, to encourage a rush to that side. After a full two second count, they pull hard to Spread -- Spread Guard looks for the first wrong-colored jersey past Spread Tackle, while Bunch Guard pulls very deep to allow FB to turn the corner, then leads him downfield.

FB sets exactly as he would to pass block, counts one second, then whips around to the Spread side, takes the ball out of QB's hand (who is faking a pass), and follows BG around end. X, H, Y and Z try to drive their men as deep as possible. We find this works much better than breaking down and trying to block defenders -- which doesn't resemble anything else we do on offense. Running deep is "normal" behavior for Wild Bunch receivers, and we find DB's will take themselves right out of this play 90% of the time.

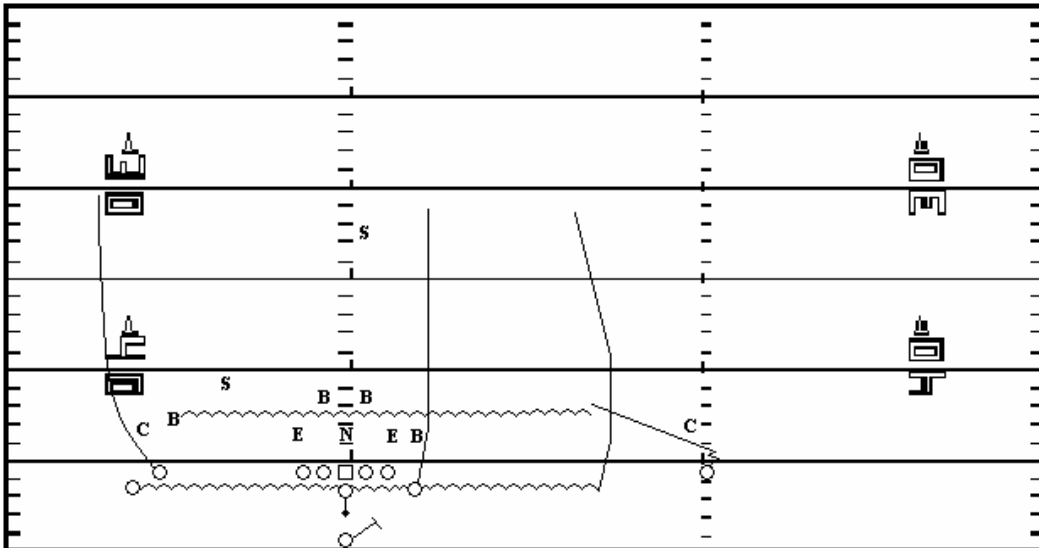

VERSUS MAN: Techniques for defeating man coverage differ for some routes. First, X will work hard to gain separation at the LOS with a quick "shake and bake" -- out-in-out steps in fast succession, followed by a hard cut inside once X's defender turns his hips out. X will continue to fight for separation, right past Z's position at the snap. Z and H run their patterns much the same as against zone, but they are looking for quick separation and a quick pass. QB should lead X with the ball if he decides to hit the Short route. This throw requires practice, but will pay big dividends.

62 FLAG

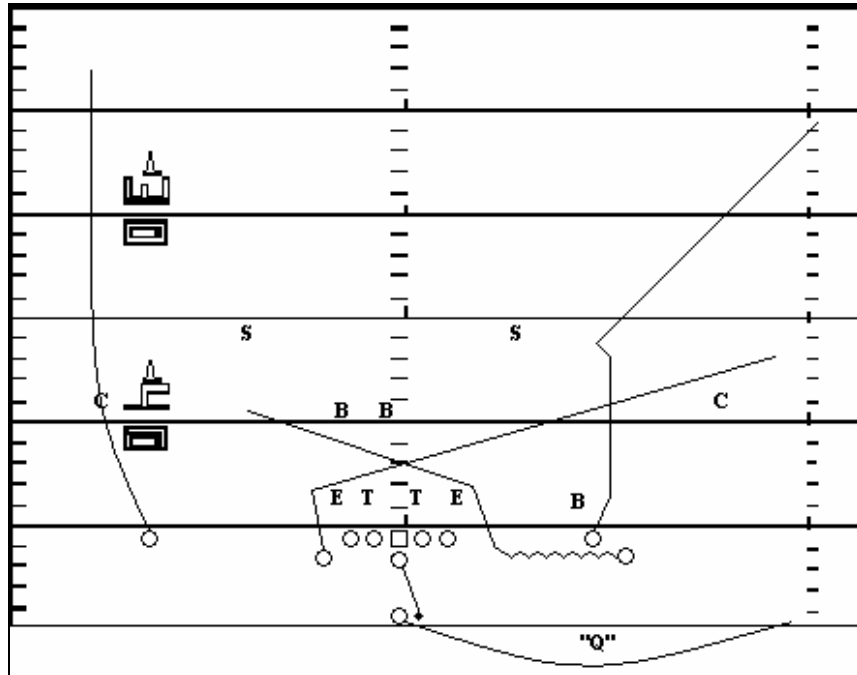

This version of the Air Raid "Kentucky Mesh" route package was first suggested to me by Coach Russell Williams of Temple, Texas. X runs an Outside Vertical route. H and Z both run Shallow Cross routes; Z crosses over H, looking for a rub on a man defender or the nearest short zone defender. Y runs a Corner route after nodding to the Post at about +8 yards. FB Swings to the Bunch side, and is the "Q" receiver in case of a blitz. Protection is 5-man BOB (see p. 30), so QB must be aware of blitzers and make use of F's Q route if he feels heat coming.

The QB read against zone coverages is simple: Y, H, FB, a very straightforward check-down. Against man, you have the QB read the mesh point of Z and H and look for the open man coming off the rub.

If defenses start over-reacting to the Bunch side when you use this route package, you have both X deep and Z shallow on the backside to keep them honest.

A very useful change-up for this route package is to tag Y with a Hook route, which gives the play a very different complexion. (Y Hooks inside and shows the QB his numbers instead of breaking to the Corner. If the ball is thrown to him, he comes back toward the QB to catch it once it is in the air.) 62 Flag Y Post is another great way to tag the play against man coverage -- you keep the QB's eyes in the middle of the field that way. He can peek at the Post, then drop down to read the results of the mesh.

63 GO

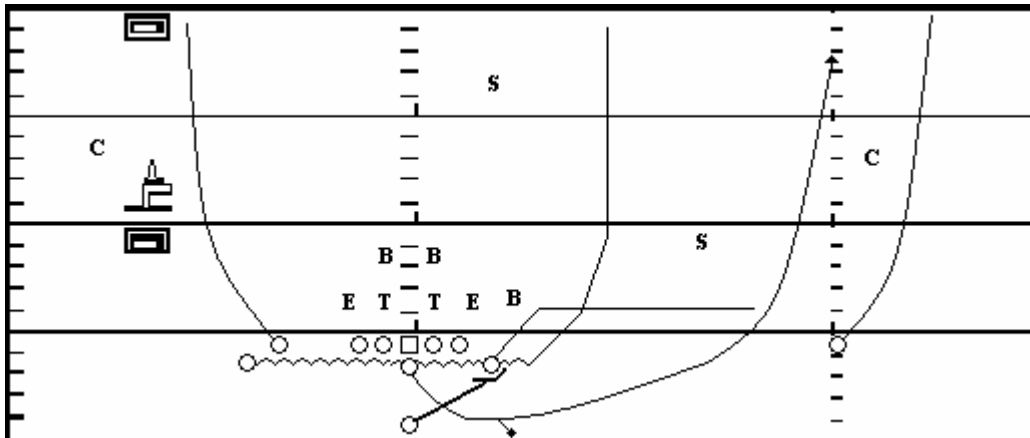

The longer I run Go, the simpler I make it -- and the more effective it becomes (and see p. 109 for the new method I have of running Go to the Bunch side, 73 Go). I no longer recommend changing pass routes with coverage; rather, the receivers run the following routes:

X and Y: Go routes with an outside vertical release.

Z: A Seam route after gaining width on his initial release, stemming slightly deeper at +1 yard (to help screen H), then cutting vertical at about +4 yards.

H: A very quick Shoot route that gets horizontal at +1 yard. Speed is of the essence -- after releasing outside at a 45 degree angle, H should snap his head and shoulders around to look for the ball as soon as he hits +1 yard.

The reads are basic: If the middle of the field is open (MOFO - two or no safeties -- p. 38), the QB will look to bracket the playside corner high-low with X and H. Practically speaking, this means looking for X and coming off to H if the corner drops with the Go route.

If the middle of the field is closed (MOFC - one safety), the QB will look to throw the ball to Z in the seam before he gets 10 yards deep; if he is covered, come off to H. The QB always has the option of breaking outside and running with the ball.

Unusual coverage schemes or defensive reactions are the responsibility of the coaching staff -- you tell your QB to look for Z on the Seam route if a Cover 2 safety widens too far off his hash to try and shut down X's Go route, for example.

64 OUT

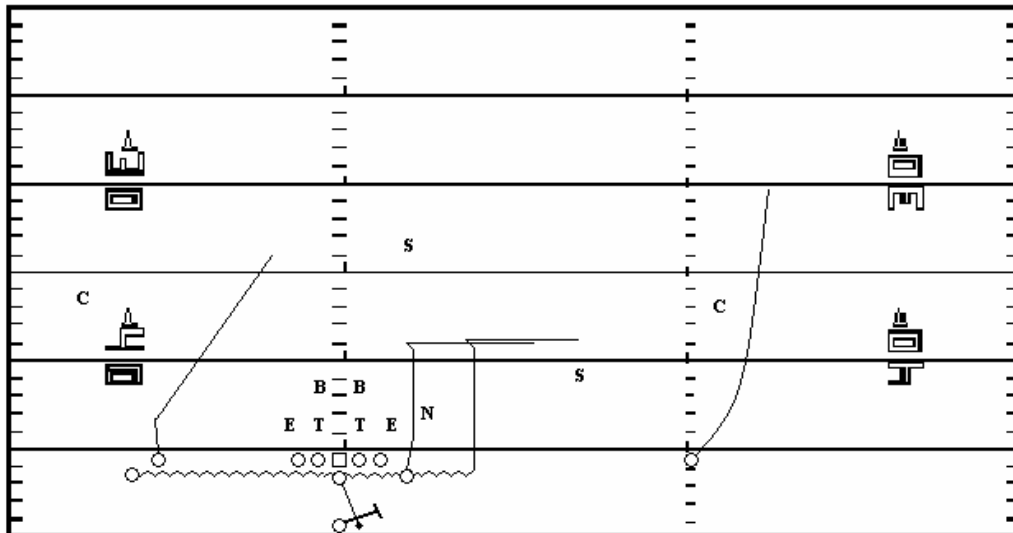

The double quick out is a favorite of June Jones, and fits in well with the Wild Bunch philosophy as one of our man-beaters. The ball gets out FAST with this 3-step route package, and it's a classic throw short - run long proposition. We consistently see big yards after catch from this package, which is especially dangerous to man coverage.

Z goes in motion about 3 yards outside H, and they both run 6 yard Outs, while X runs the same Outside Vertical route he would in 63 Go, and Y runs a quick Slant. The QB's read consists of checking the leverage on H and Z. The only sure way for the defense to cover a quick out route is by placing a defender close to the LOS with outside leverage on the receiver.

If either receiver does NOT have that kind of defender on him, throw him the ball as soon as he cuts. If both do not, choose the one who has more room to run to. And if both DO have tight outside defenders on them, throw the quick Slant to Y on the backside. We can also tag Z and/or H with Slants to take advantage of tight outside coverage. Another option is to tag one or both receivers with Out-and-Up routes, which becomes a 5-step drop.

65 IN

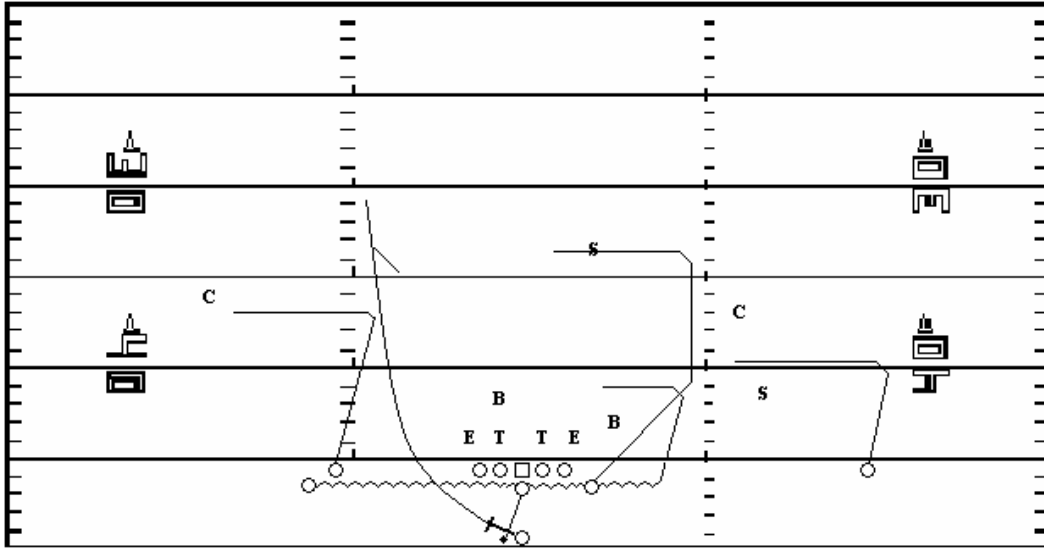

Another favorite of June Jones, who calls it "Levels." (Homer Smith calls it "Tracks.") It is excellent for attacking Cover 3 as a variation on the four-verticals plan of attack. (In fact, if teams stay in Cover 3 against us, we can alternate among 50 Seam (p. 91), 63 Go (p. 101), 74 Mesh (p. 110) and 65 In as our passing game plan.)

Z goes in motion to about 3 yards outside H, and runs a 4-yard In route. X runs a 5-yard In, while H runs a 12-yard Angle route -- he slants outside to a depth of about +5 yards, stems vertically, and then breaks in at +12. His outside release is important so that Z doesn't screen him from the QB's view. Y runs an 8-yard Out, while FB checks the weakside rush before releasing on a Seam route. He reads the CB on his side while releasing -- if he squats or man-locks on Y, FB will break back down his Seam route toward the QB at about +12 yards.

The QB reads Y first. If the Out is there, throw it. If not, he locks on H, who along with Z has the weakside hook-to-curl defender (usually the Will LB) bracketed high/low. If Will drops with H, QB comes down to Z. If both are covered, he comes off to X trailing the play. X will settle in the hole between the flat and hook defenders against zone, or accelerate away from a man defender.

66 RAM

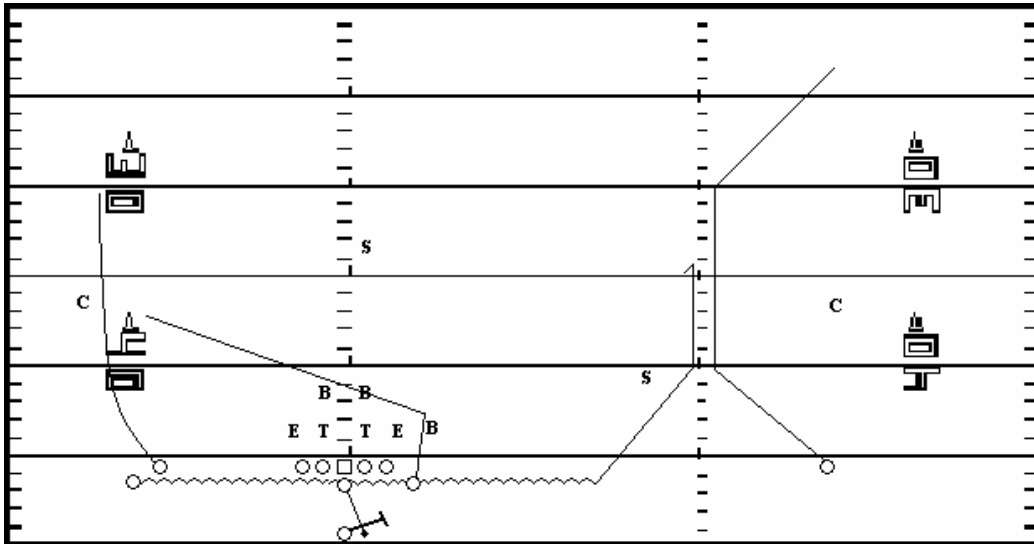

Ram offers us a man-beating package with "Run and Shoot"-style 60 series motion. Z goes in motion until he is halfway between H and X, and slants outward until he is a yard inside the Spread-side hash by the time he is +5 yards deep. X, meanwhile, slants in until he is a yard outside the same hash at the same depth. Both then head straight down the hash. (This is especially effective against teams that try to cover crossing receivers with a two-man banjo -- Z and X look like they will cross, but don't.)

Z ends up Hitching at +10 yards, while X breaks out to the Corner at +15. A very effective tag has X cut instead to the Post at the same depth ("66 Ram X Post") which we can also audible to as "Facto."

("Ex post..." -- never mind.)

Since we view this as one of our man-beaters, the QB will look for Z first on his Hitch, then to X's Corner route. If the defense starts to sell out to the motion side, you have H on a Shallow Cross and Y running down the far numbers.

If man defenses catch on to this package, we simply tag it with "Switch," which tells X and Z to cross at +5 yards and run each other's routes.

This package is best run from a hash with the Spread side of the formation set to the wide field.

68 DRAW

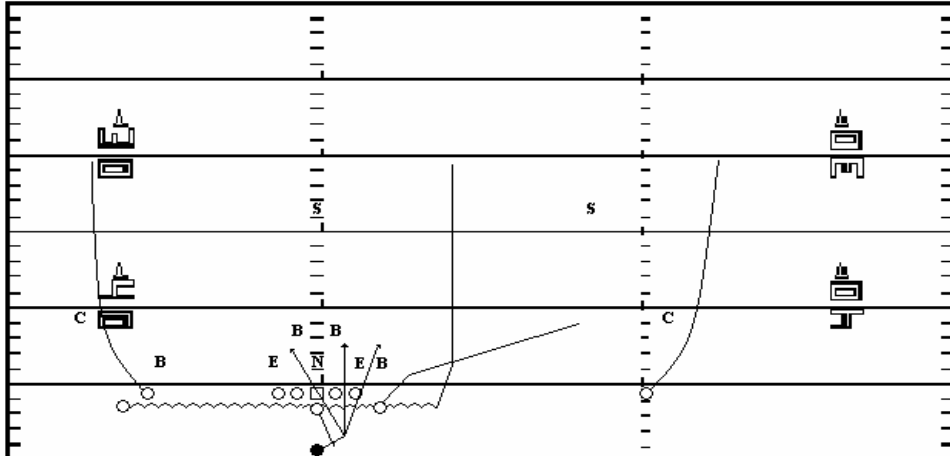

From 63 Go action, F sets up in his normal pass protection technique. QB drops behind him, holding the ball in a passing grip and, on the third step of his pass drop, reaching around behind F and sliding the ball into F's gut. He then continues behind F to his normal passing depth, faking as though he is still holding the ball ready to pass it. F needs to take a full "One—one-thousand" count before he starts running, in order to encourage the underneath defenders to continue dropping.

Running the R&S version, after we burned the OLB once with Draw, no one went near H's Shoot pattern from Go for the rest of the game. Although we generally only call Draw when defenses drop their EMLOS defender on the Spread side into coverage, we have run right by defenders who are so intent on rushing the passer that they miss the backside hand-off. Having that defender over H drop is actually very common after we hit a few passes to H.

Coach Nick Cursley, formerly of Kent Exiles in England, reports that the Draw works even better from longer motion, as with 60 Short (p. 98) -- perhaps the longer motion has an even greater "convincing" effect on defenses.

70 ARROW

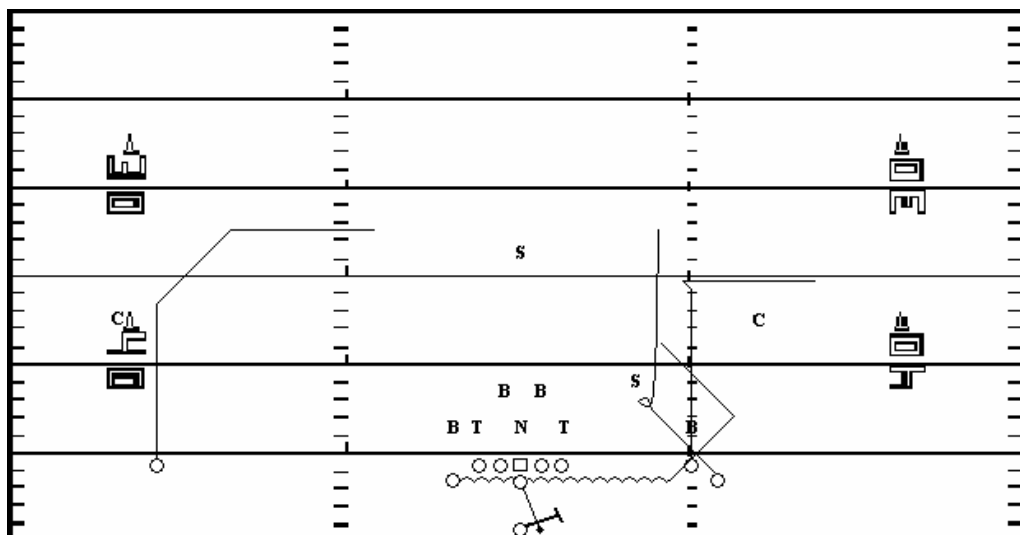

One of the "evil twins" (homologous route packages) of 74 Mesh (p. 110 - - the other is 75 Shallow, p. 112). Once defenders get conscious of Z's Whip Read in 74 Mesh, we send him deep on a Whip-and-Go ("Whiggo"). Y's 9-yard Out makes room for the signature "Arrow" or "Texas" route by H; Y will also gain quick separation from defenders looking for a Smash cut. Flat defenders, either straight man, banjo or zone, will get caught flat-footed by the Arrow after a steady diet of flat routes by H. X's backside Dig, with half the width of the field to operate in, is especially hard on Post-conscious man defenders.

Tags are an important part of the 74/70/75 "trinity." Just as we can simply tag Y with a Post rather than a Corner route in 74 Mesh (p. 110), so we can also keep the Whiggo hidden as a surprise by running 70 Arrow Z Whip the first few times we run the play. This series of plays is almost infinitely adjustable to allow you to maintain maximum pressure on defenders.

71 NINER

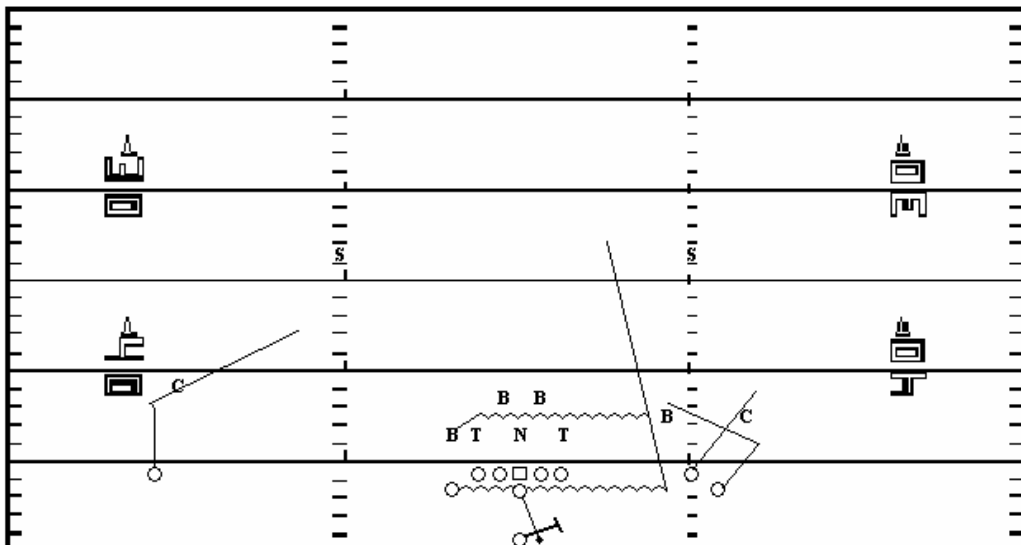

The In-Slant combination made famous by Jerry Rice and Bill Walsh, a truly great man-beater route package. H clears out inside coverage, Y releases at the inside shoulder of the outside defender, while Z starts toward his outside shoulder before cutting sharply up and In. If the defense tries to stop X's Slant by bringing help over on the inside, they open up the In combination. On the other hand, leaving our best receiver in single coverage and lots of field to run to is not percentage defense, either. A great end-of-half route package, as Coaches Coverdale and Robinson point out. Loose C5 (C2/ Man Under) is especially vulnerable to a big run after catch by X or Z.

72 DEUCE

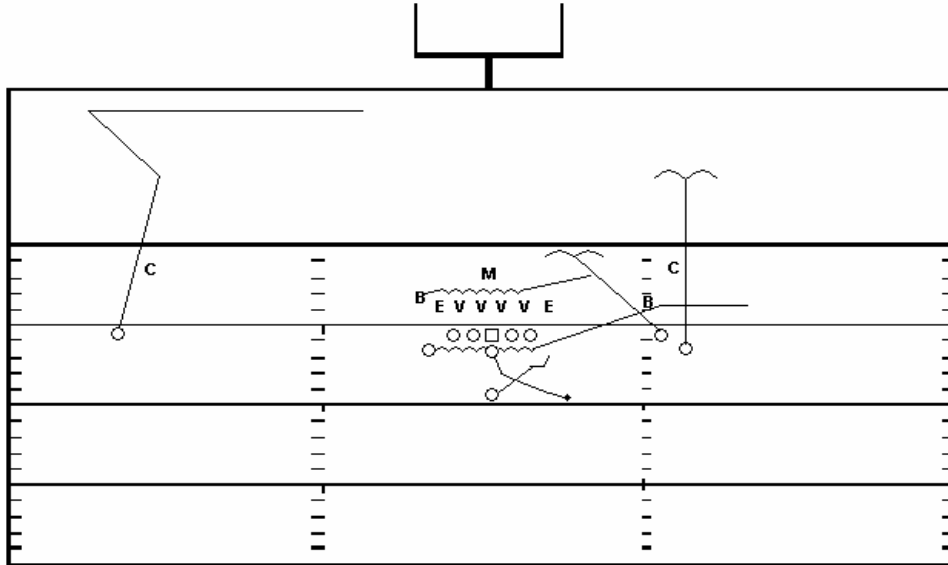

I have used this play in various forms for years as a reliable two-point conversion shot (as the name indicates), but it also has value on the goal line and as a 3rd-and-short play. I have diagrammed it here from the five yard line.

H starts in motion toward Bunch, but the ball is snapped when he is directly behind Bunch Tackle. From there he runs a shallow Shoot route. Z runs an Option route at about +10. Y runs a Barrier Option route -- he runs through the outside shoulder of the man covering H, then settles at about +5 just outside Bunch Tackle and slides laterally, making eye contact with QB only if he is open.

QB, rolling to Bunch, looks first for H breaking open quickly. If he is covered, switch to Z, then Y. Finally, X has run a Corner route and is now running along the back of the end zone. QB should look for him before he pulls the ball down and runs for the flag at the corner of the end zone.

73 GO

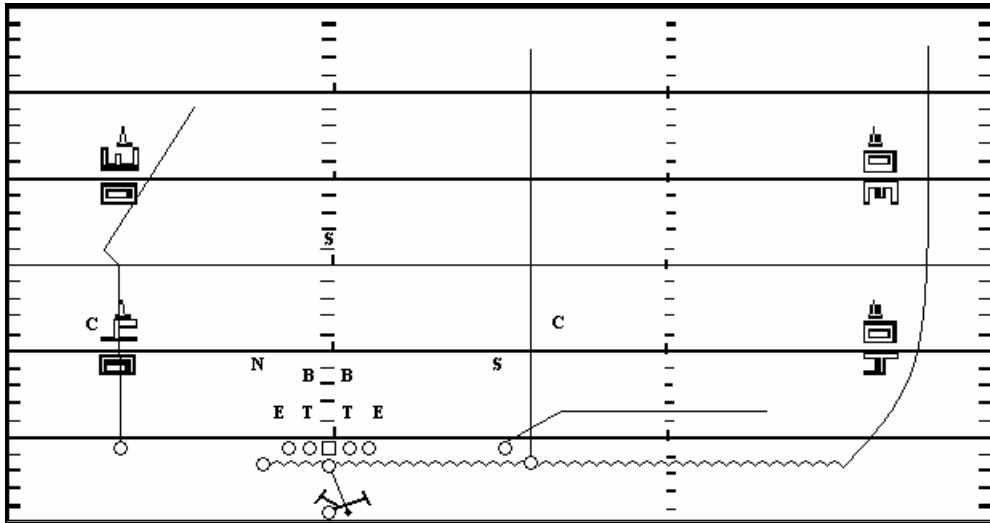

This is a fairly recent addition to the Bunch-side repertoire of the Wild Bunch, along with 77 Curl-Flat (p. 114). After defenses have seen a great deal of H's "70" motion to form the Bunch, we run 73 Go or 77 Curl-Flat and watch the panic as H's motion just keeps going, and going, and going...this obtains the absolute maximum horizontal stretch on the secondary possible before the ball is snapped. It also gives us a great deal of time to observe defensive adjustments to the very long motion by H, which in turn allows us to game-plan follow-ups to this play.

The elements are identical to 63 Go, with the added possibility of defensive confusion and error the first few times you run it to Bunch. H has the Outside Vertical route, Z the Seam and Y the Flat or Shoot route at about +2 yards. Against zone you are bracketing the outside underneath defender with two receivers (Y and Z against Cover 3, Y and H against Cover 2); against man coverage you have a natural rub between Y and Z to gain separation for one or both of them.

74 MESH

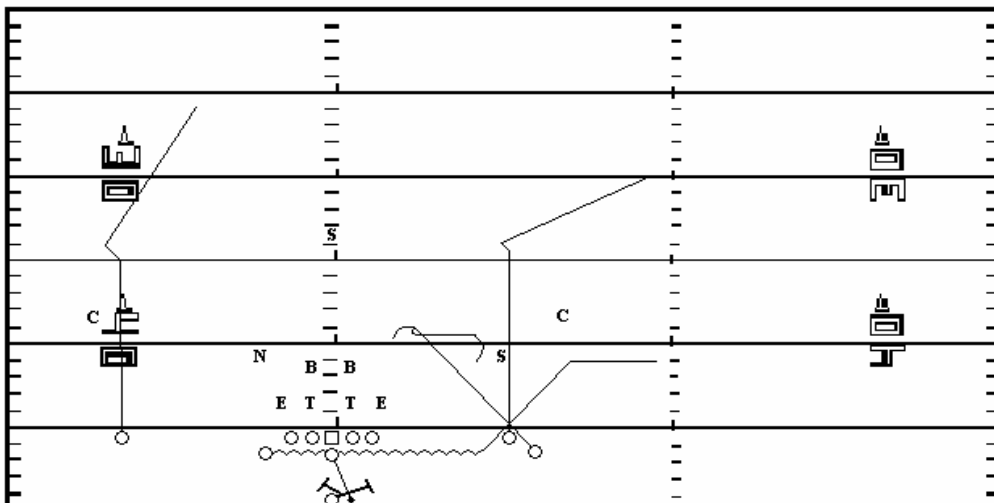

If I were somehow limited to one pass route package from the Bunch, the Coverdale and Robinson Mesh would be it. Among other things, it is very easy to tag receivers with alternate routes from the basic route package and defeat all sorts of defensive adjustments. 70 Arrow (p. 106) and 75 Shallow (p. 112) can, in fact, be called from the sidelines as Mesh variations by tagging receivers with different routes.

H motions to a yard inside Y at the snap. Y runs a Smash, H a Flat route underneath him at +4 yards, and Z runs a Whip Read at about +6. H and Z literally rub shoulders at the Mesh point.

C3: Look to H right now -- if flat defender jumps him, shuffle a few steps and hit Z's Whip as he snaps his head around into the hole left by the flat defender. Throw the ball right in the hole, stopping Z in his tracks. If a hyper CB is prowling the Flat, we may pre-determine a pump-fake to H and deep shot to Y.

C2: If PCB drops, hit H now. If PCB squats or moves laterally, hit Y's Smash. NEVER TRY TO THROW OVER A RETREATING CB. Z sits in the zone window as your outlet.

C4: Bracket the Bunch flat defender between Z and H.

C1: Look to Y to beat the safety. If the safety crowds the Bunch, come back to X on the Post. H is "Q" receiver against blitz, Z is outlet.

C0: Consider SWAP adjustment at LOS (Page 15, upper diagrams). If you have time, Y's (or X's in SWAP) Smash can be a big play; otherwise, think H in the Flat, then Z's Whip Read.

74 OPTION SCREEN

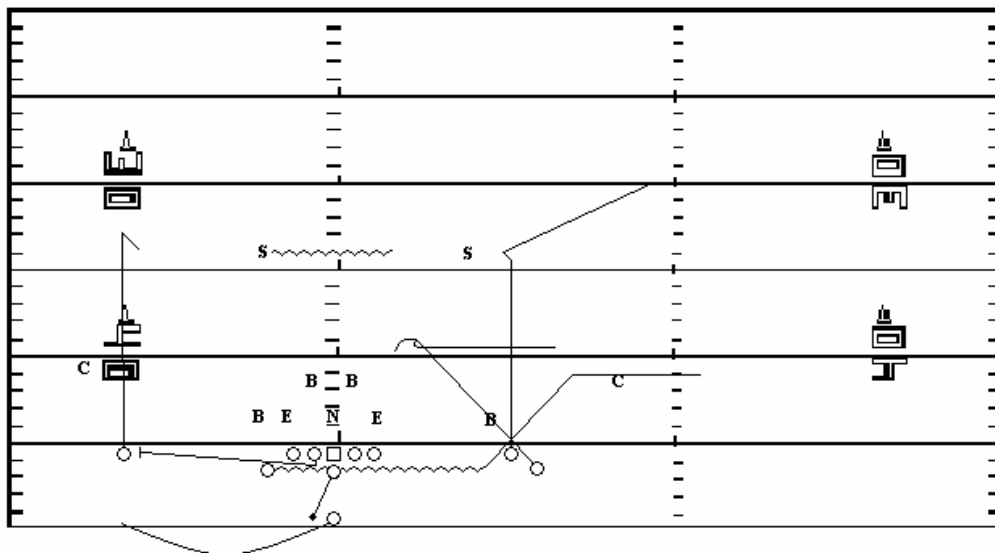

Against defenses that overload the Bunch side, we like to incorporate this Homer Rice "option screen" look into Mesh. QB reads the defensive reaction to H's motion: if the secondary slides or rotates to Bunch, or if the OLB chases H across the formation, QB calls "Short! Short!" to alert line, X and F, then drops facing Spread and reads the CB. The Center or Spread Guard, whoever is uncovered, pulls flat down the line in the direction of X's original position, looking to kick out the first defender who shows. Rather than blocking frontside, F now Flares backside and looks for the ball immediately after the snap (he becomes the "Q" receiver if QB exercises his screen option). If the CB comes up to meet the screen threat, QB hits X, who has adjusted his route to a 12-yard Hitch. If the CB stays home, QB dumps the ball off to FB with a blocker leading the way.

If both the secondary and OLB stay in place, QB forgets about the screen and reverts to his normal Mesh procedures: he drops facing Bunch, and executes his Mesh reads. (If you're worried about defenses keying the "Short" call, have your QB also call it on a few completely unrelated plays.)

75 SHALLOW

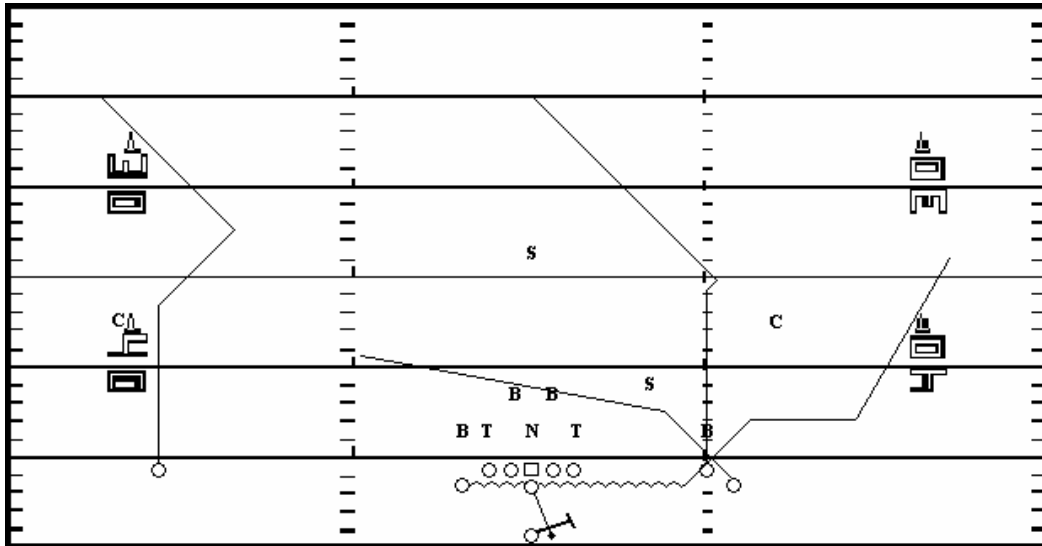

The third member of the homologous "trinity" (along with 74 Mesh, p. 110, and 70 Arrow, p. 106). Y now runs a Post, Z a Shallow Cross, and H turns his Flat route into a Wheel by breaking downfield and toward the sideline. Z should be wide open the first few times you run Shallow after 74 Mesh, and Y can give you a big play potential if defenders have been seeing a steady diet of Corners from him in 74 Mesh. For the same reason, H has real potential to break open if defenders have only seen Flat and Arrow routes from him with 74 Mesh and 70 Arrow.

Since we use 75 Shallow as a change-up to 74 Mesh, the QB's prioritization of his routes will most likely be a matter for game-planning. Having said that, he can progress from Y to Z to H without too much trouble.

76 SWITCH

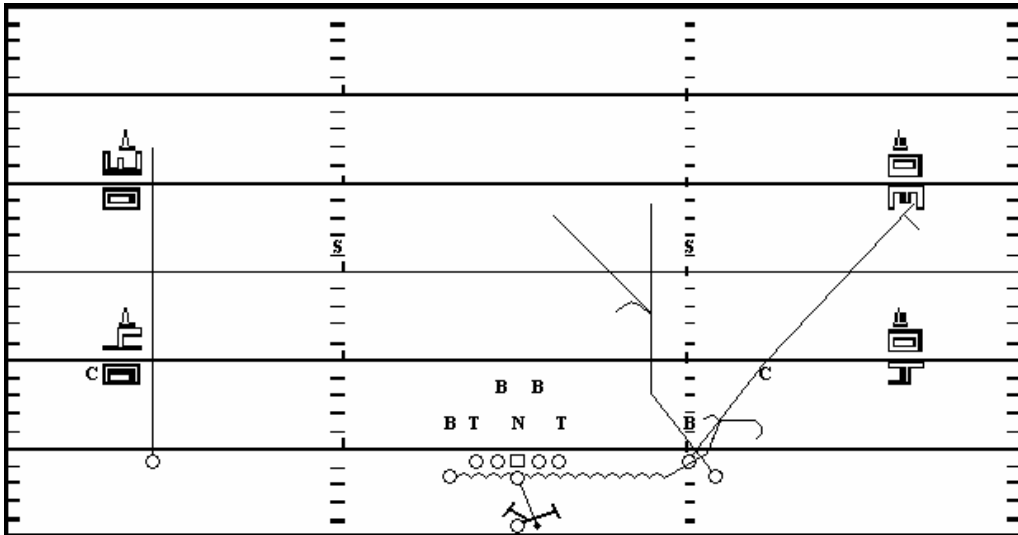

Z reads the nearest safety on the run -- if he stays deep middle, Z runs the hash alley, looking for the ball at about +20. If the safety widens or against C0, Z breaks hard to the Post. If the safety floats over the top of Z's hash mark alley, Z hooks up inside at +14-15. Y essentially runs a Fade through the near shoulder of Z's defender. H's rule is simple -- get open. If in doubt, head for the sideline, stopping in a zone hole if one opens. X runs deep, trying to take two backside defenders with him. Don't neglect a deep shot to X if he's coming open. QB reads reaction to H's motion.

Versus man, we will predetermine a deep shot to either Y or Z right off the rub. If the deep route isn't open, hit H breaking away from his man. Against zone, QB looks off deep, then throws to the area where H is breaking. This is a timed throw while short defenders are still dropping. If H's Choice route is jumped from inside, look for Z running his hash.

77 CURL-FLAT

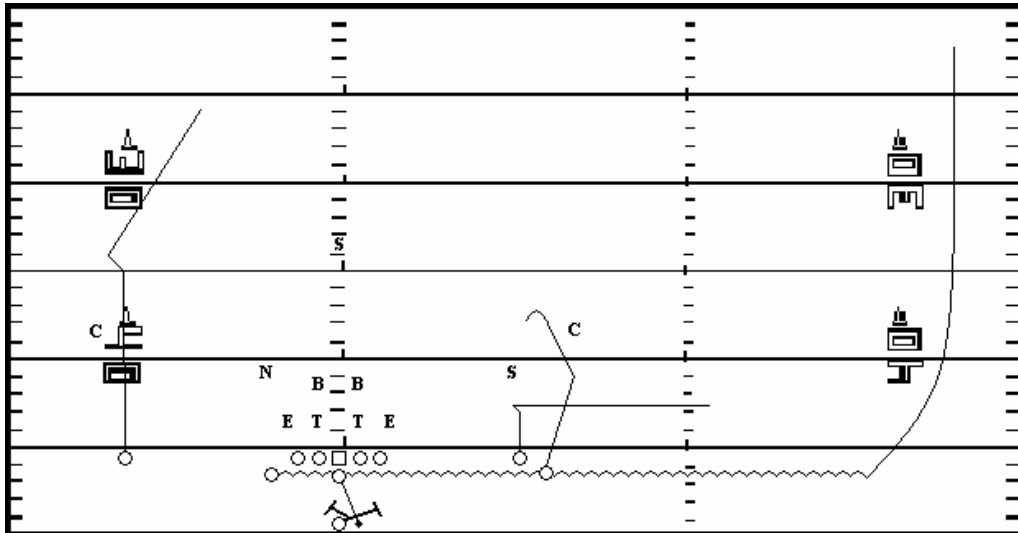

This is the classic Curl-Flat route combination, with the added benefit of H motioning out to the top of the numbers, stretching the defense from sideline to sideline and opening up space for Y and Z to run their two-man combination. It is a great change of pace from 73 Go (p. 109).

Even though Curl-Flat is a classic way of attacking the underneath defenders in Cover 3, I believe this play has excellent potential as a man-beater as well, with Y and Z crossing and gaining separation from tight man defenders. Z gains width at the snap before cutting toward the Post at +4 yards, then snapping around and Curling toward the QB at about +8. We can obviously tag him with a Post, or even a Post-Corner, if the underneath defenders start playing him too tight.

Y breaks Out at +2 yards and looks for the ball immediately, snapping his head and shoulders around as he breaks. Against Man coverage he should nod his head and shoulders hard to the inside as he takes an inside step, then snap outside; against zone coverage he can square off his break to the outside.

Depending on how teams defend this, we may look for H down the sideline, or else concentrate on the two-man game between Y and Z. If the QB gets a zone read from H's long motion, he should look for Z's Curl, then come off to Y's speed Out. Versus man coverage, I would prioritize Y's Out. And don't forget about X -- he should be your best receiver, and they can't be paying him too much coverage attention with receivers spread out all over the field...

78 QUICK

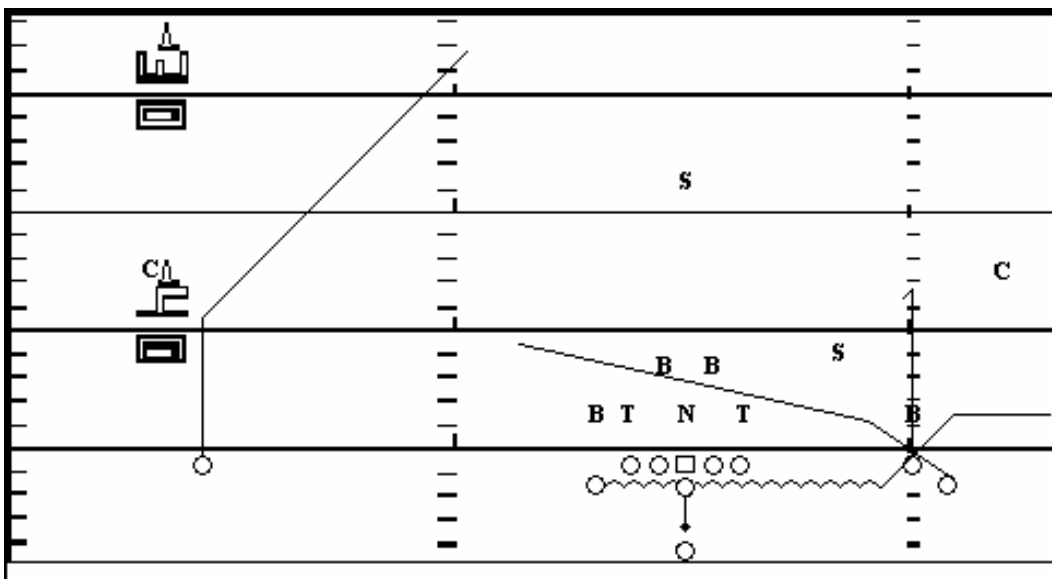

Very quick two- or three-step drop. This “fourth musketeer” to the homologous route packages 74 Mesh, 70 Arrow and 75 Shallow is an ultra-fast way to get the ball out in space in the hands of one of your better athletes. It tends to work best against zone defenses that are dropping quickly, or loose man coverages that will allow you to get the ball to H very quickly on his 2-yard deep Shoot route. Y runs a quick Hitch at about +6 yards, and Z has a Shallow Cross.

If you have been throwing a steady diet of 74 Mesh and its homologous route packages, Quick becomes a great way to hit the empty spaces defenders are vacating as they drop deep in reaction to your pass action.

79 TURN

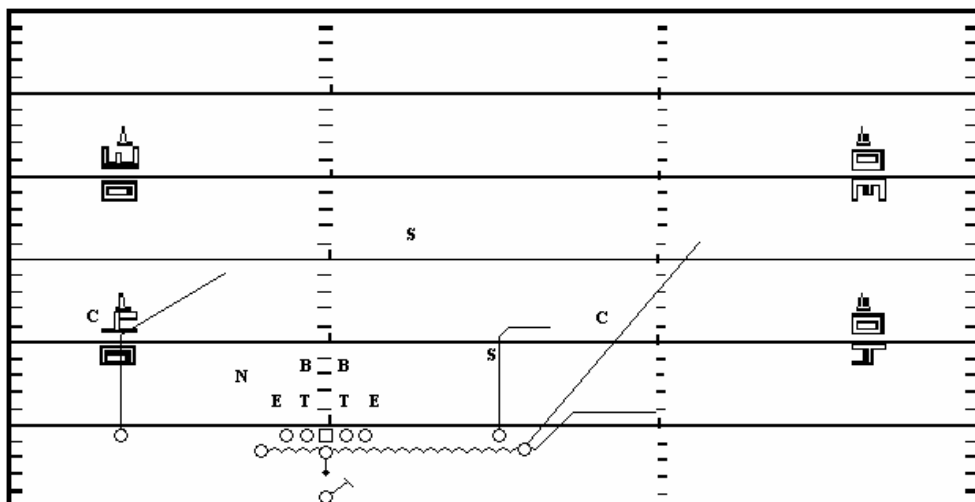

Also known as "Y Stick", Turn gives us a similar weapon to the Bunch side that 60 Short provides to Spread. H runs a quick Shoot at +1 from behind Z, looking for the ball as soon as he breaks outside; Y runs a Turn, breaking outside at +6, while Z runs a landmark Fade that puts him about 16 yards wide of his tackle and at about +10-12 when the ball is thrown. From a quick 2 or 3-step drop, QB's read is the first underneath defender inside the PCB. QB is thinking Turn -- the Shoot pattern becomes a reaction if the defender takes the Turn away.

VERSUS ZONE: The Bunch-side flat defender is QB's read. If he hangs and takes away Y's Turn, throw the Shoot immediately to give H space to run to. If he jumps the Shoot, Y will have lots of space to make the catch. Hit his downfield number with the ball to let him spin and head straight downfield in the same motion.

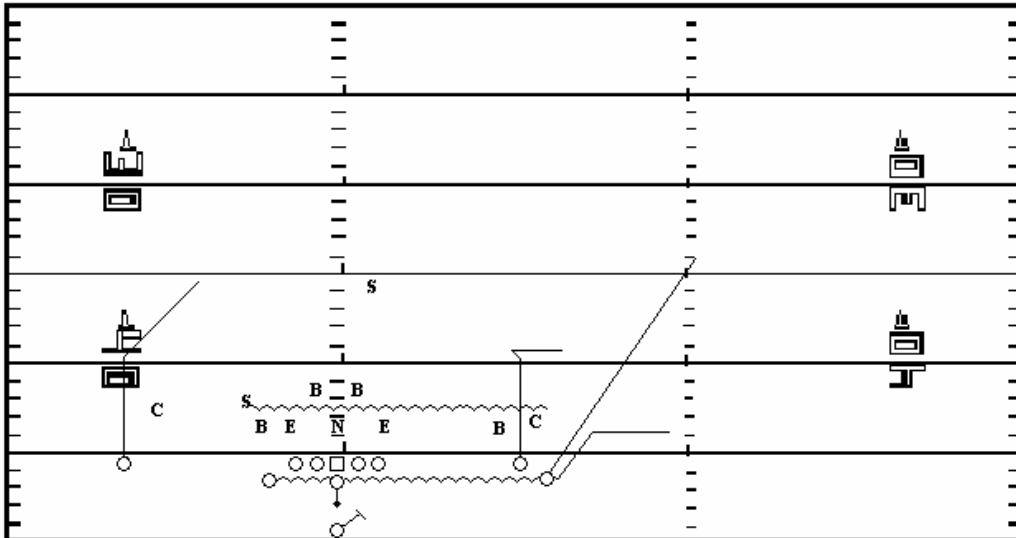

VERSUS MAN: H's motion complicates his man's job enormously -- there are too many bodies to run through to cover the quick Shoot with any reliability. Switching won't work, either -- notice all three patterns are breaking outside, leaving an inside switcher with nothing but air to cover. Bumping coverage is probably the best solution, but we probably have a speed mismatch somewhere, most likely Z's Fade -- if QB can hold the ball and wait, we can hit a big play.

Note: While I have diagrammed this play from the regular Wild Bunch formation, it seems to work even better from SNUG, page 14 -- the shortened playside corner gives Z and H even more room to run to.

80 NOW

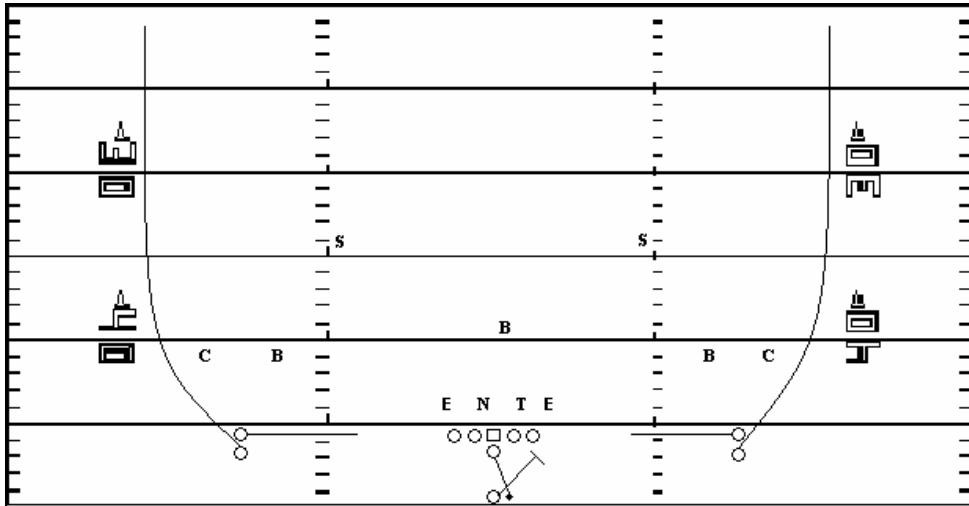

This STACK route package seeks to take advantage of defensive tip-toeing. The quick down-the-line release by both X and Y requires an immediate defensive reaction, or else one of our best players will get the ball right now with space to run to. The double Outside Vertical releases by H and Z, meanwhile, put horizontal and vertical pressure on the secondary as soon as the ball is snapped.

We ask our QB to look over the defense before the snap and decide which side he will go to after the snap. If the defense lines up more or less as diagrammed, he should simply choose the side where he thinks we have the better match-ups. At the snap he will look immediately to the LOS receiver coming toward him. If he looks to be open, throw him the ball (this is a "touch" pass since the receiver is heading in his direction, but it is not a lob or a puff-ball. It takes practice to get the kind of 50-60 percent velocity on a flat trajectory ball that this play calls for). If the LOS receiver is covered, look for the receiver going deep.

If the defense spreads out seven defenders to cover our STACK formation as diagrammed, do not overlook the obvious possibility -- run the ball! Both 35 Quick Trap and 36 Zone can be great calls against this defensive look. We also have the option of running 10 and 20 series plays from STACK, depending on how the defense is lining up. See 83 Drive and 84 Bubble (pp. 121 and 122) for what the motion to 3STACK looks like.

81 NOW SCREEN

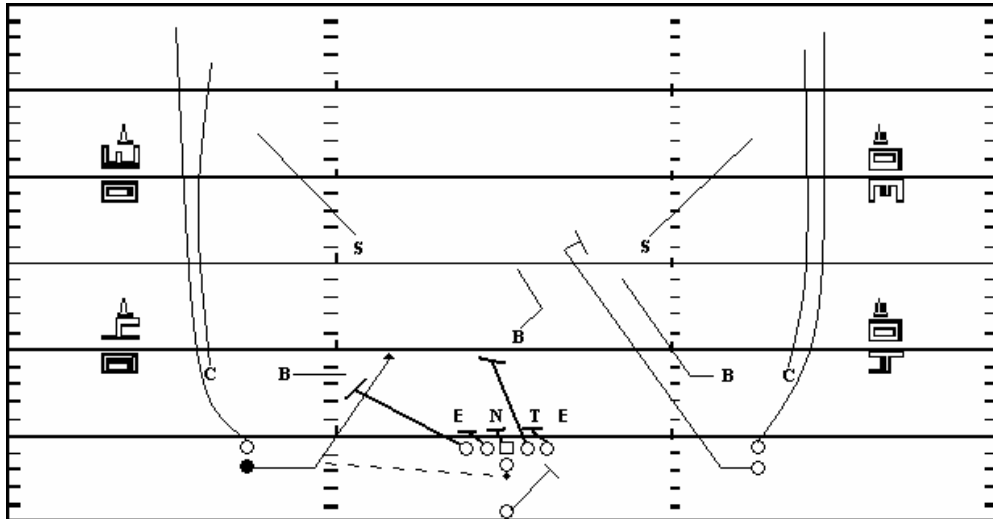

The Now Screen switches responsibilities between the LOS receivers and the players behind them. It is especially useful against tight man coverage such as Cover 2/Man under, or what I call Cover 5. At the snap, X and Y release deep on Outside Vertical routes, pulling both underneath man defenders and the hash safeties to them for the first few crucial seconds. H and Z, meanwhile, break straight in toward the QB. Z cuts downfield on a Slant route on his third step, but H continues straight ahead until he gets a half-speed throw from the QB. He then cuts downfield behind the block of the Spread Tackle, who has taken off straight for H's man defender.

(Your linemen will love this hit, by the way. The defender usually concentrates all his attention on H...)

82 SLANT-FADE

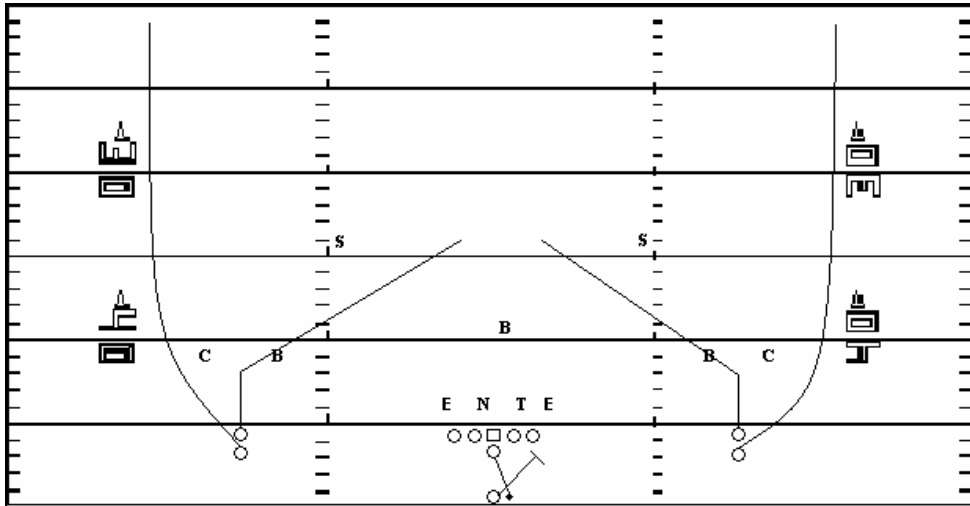

One of my favorite man-beaters. X and Y run quick Slants, breaking in at about +3 yards, while both H and Z take Outside Vertical/Fade releases. Like 80 Now, this calls for a pre-snap read to see which side looks better for the throw -- through defensive alignment and/or personnel mismatches. The read to the chosen side is dead simple -- Slant, then Fade. Again, running the ball against a spread-out defense is what the Wild Bunch is all about, so don't neglect it from this pass route package -- 35 Quick Trap and 36 Zone, in particular.

83 DRIVE

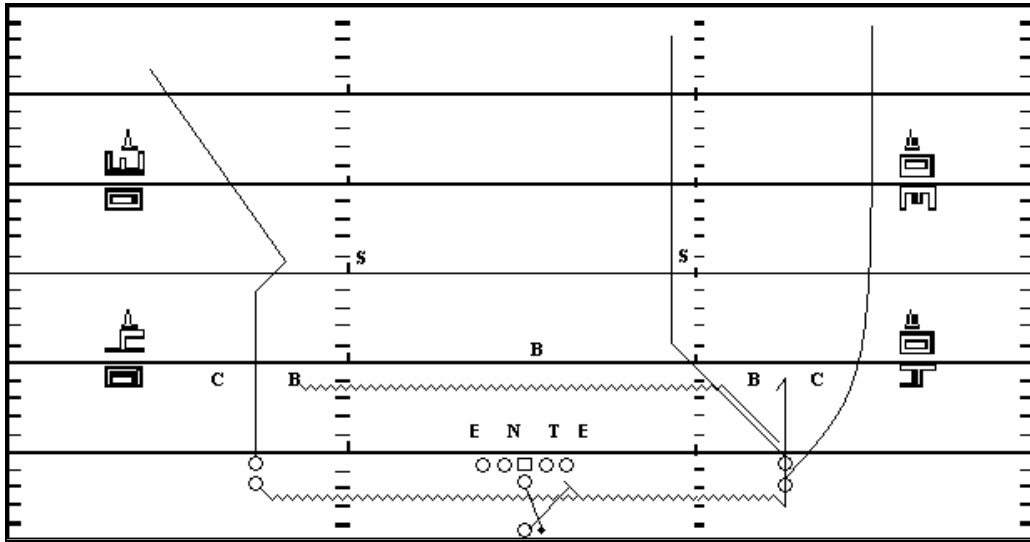

This concept demonstrates the power of the 3STACK variation. We will motion to it from STACK, although we can of course line up on the ball in 3STACK. (Similarly, there is nothing stopping us from lining up in 3STACK and motioning to STACK, or even using the "Scatter" shift and adjusting to either STACK or 3STACK -- p. 19.) I prefer to motion to the right as shown above, but there is nothing stopping you from using motion in either direction to create 3STACK Right and Left.

Y slants inside at the snap, then runs the inside of the near hash looking for the ball. Z takes an Outside Vertical release and runs down the top of the near numbers. H bolts straight downfield at the snap, then slams on the brakes and Hitches inside at +4 yards. X, meanwhile, runs a Post-Corner route on the backside.

This package is intended as a man-beater, especially if the defense wants to play what I call Cover 5 (Cover 2/Man Under). You have Y and Z bracketing the trips-side safety with their routes deep, while X holds the attention of the other safety and H provides a quick outlet down low. This package will also work against zone coverage, however, and H makes an excellent outlet from his short zone window.

84 BUBBLE

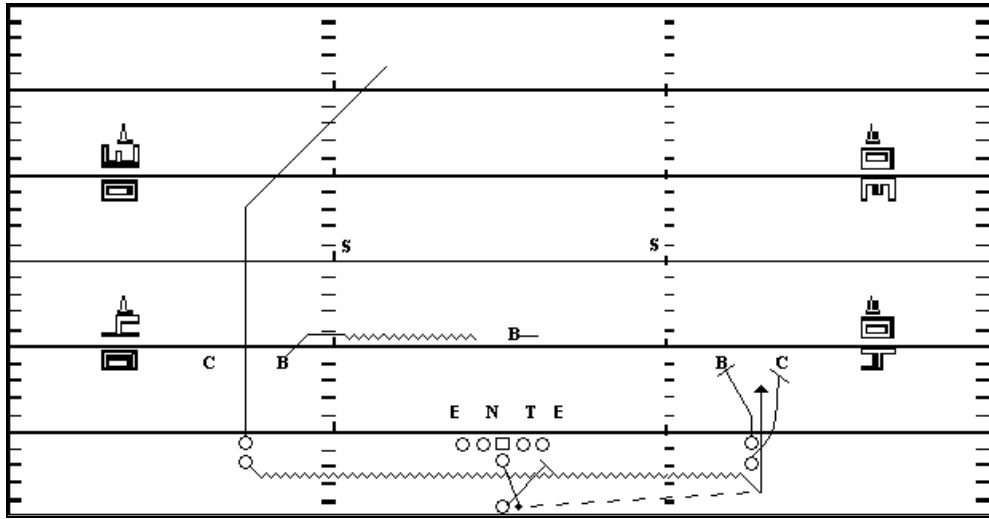

Another 3STACK route package. This tests the defensive reaction to the 3STACK motion. If they don't get three men out on our 3STACK right away, we will throw this quick bubble screen all day long. It also sets up one of my favorite specials (see 97 Double Pass, p. 131).

With H in motion, of course, you also have the 10 and 20 series to play with, depending on how the defense is aligning. If they play off the LOS expecting the pass, you can run the Fly and Rocket series instead. Y and Z would release deep and screen their men once they reacted up to stop the run.

88 MAX TWIST

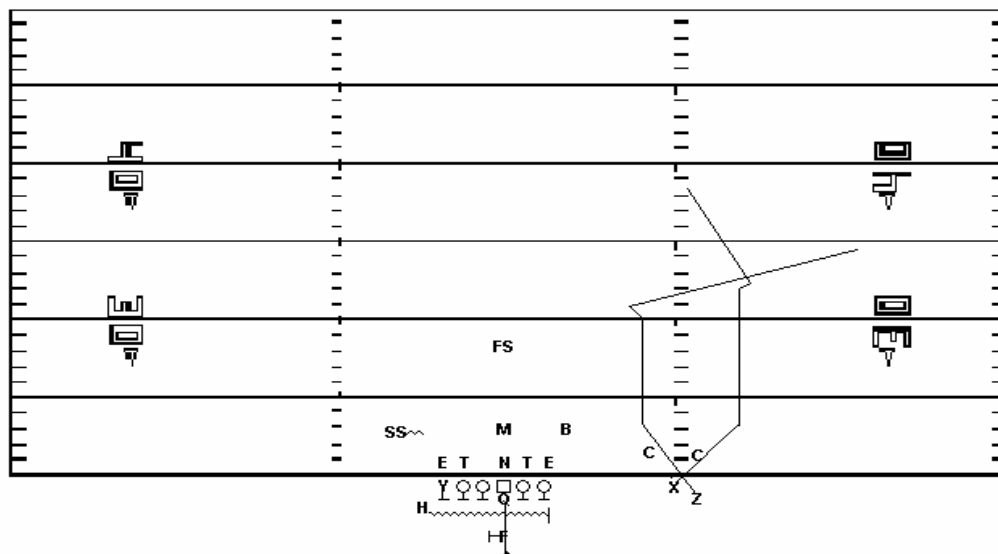

Our nickname for this package is "dueling banjos", since any attempt by the two man defenders to switch receivers at the outset will come to grief when they cross again downfield.

Z releases inside, looking to rub his man off as he passes underneath X. This package also resembles the Vertical Switch so far, until Z nods to the Post at +10, then cuts back for the corner, looking for the ball as he breaks. X has released outside, then turns his Middle Read into a "skinny" Post at +12 after sharply nodding to the outside. The two excellent man-beating routes are packaged here in a way that makes coverage difficult whether the defense plays it straight or attempts to switch off. And to quote Bill Walsh on check-releases (see p. 125):

"There should be a better way to protect the passer than we do. One way is to use the "tight end" [Y] plus "H" & "RB" [F] as pass protectors. All three of them would check and then release, but you would have a way to pick up eight rushers.

"You have eight blockers. You'd have a way to pick up eight people. You have two receivers working against man-to-man coverage. Then as those people checking and then releasing, they would release on patterns that would be open vs. the zone. So you could deal with the zone with your late releases, you could deal with man-to-man with your two best receiving people, but you can protect the passer."

89 MAX WRAP

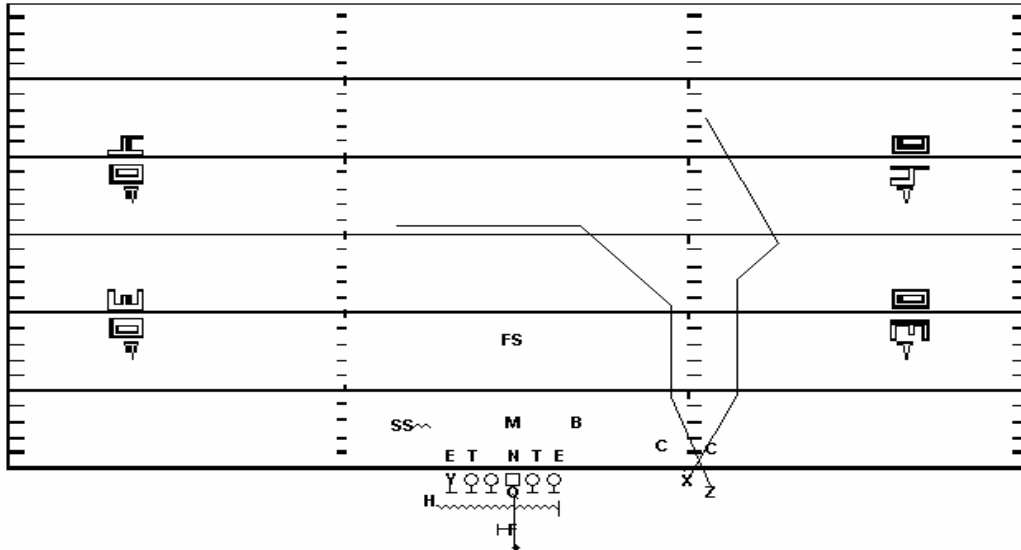

A third way to mess with tight Man coverage, this package is good against the coverage diagrammed, but even better against Cover 0 if you can keep the blitz out. The initial rub can give Z the separation he needs to get open on his Dig route if they plan straight Man, while X's Post will usually defeat a DB maintaining outside leverage if they switch coverage.

Z pushes up and inside for five yards before he pushes hard straight downfield to +10 or so. There he cuts to the Post, looking to make eye contact against a free safety, before cutting horizontal at +15-16.

X gains width at the snap, then straightens out and takes it downfield to around +12. There he drives for the corner for two or three steps, then cuts back hard on a skinny course to the Post.

As with all three MAX route packages from SWAP, Y, F and H are all free to release into pass routes once they are sure no rush is coming their way. These check-release routes will necessarily be limited in scope -- Flat routes for H, Swing or Arrow routes for F, Delay routes for Y -- but they can still help get 5 receivers out if the defense decides to drop off and cover rather than bring the heat.

90 SERIES: THE SPECIAL PLAYS:

If there is one golden rule about running specials (or "trick plays", as they are sometimes disparagingly known), it is to get yours in first. Paul Brown was a great believer in this theory, at Washington Massillon High School, Ohio State, and later with the Cleveland Browns and Cincinnati Bengals. Bill Walsh has said he learned this lesson while coaching under Brown in Cincinnati. Brown would be absolutely livid if the other team ran a special before he could run his.

More generally, these plays should be used sparingly during the season. They can be a great morale booster in practice -- there is nothing most players like more than to think they are putting one over on the other team. You may want to work on variations that can be run later in the year of plays you have shown once or twice, especially if they were successful.

SERIES/PLAY

PAGE

90 SPECIALS:

91 Fly Reverse

128

93 Spread Guard Special (SGS)

129

95 Rugby

130

97 Double Pass

131

91 FLY REVERSE

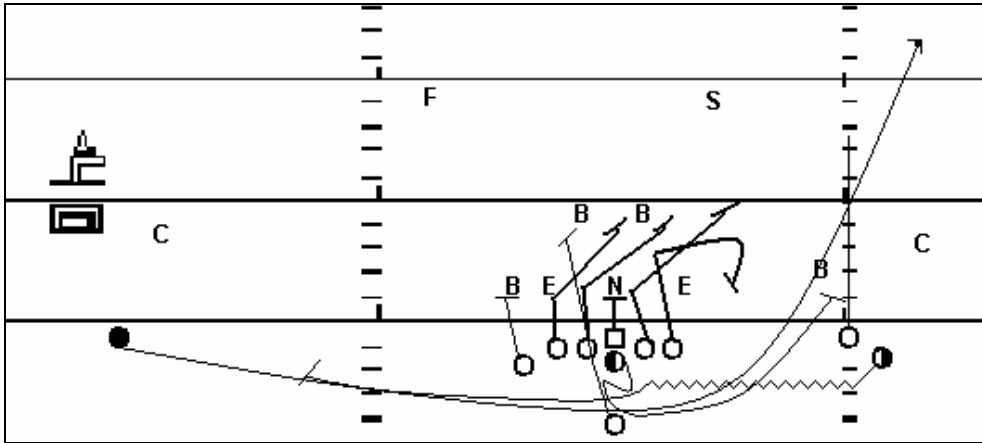

This is yet another play suggestion from Coach Russell Williams. We execute the 19 Fly Sweep (p. 52), but in this case X breaks inside toward the sweeping Z to take a hand-off and continue around the Bunch-side end. The line and H start toward their Fly blocking assignments, but then peel off to pick up defensive leakage to the Bunch side. The QB has an important job -- his bootleg fake turns into a block sealing the defense inside or else pinning them toward the sideline as X brings the ball to the Bunch side. This can also lead to a double fake, where QB fakes to Z who fakes to X, while the QB rolls to Bunch on a run-pass option play.

This is probably best run with the Bunch side to the field, which brings X closer to Z for the hand-off -- but it can also be run as diagrammed.

93 SPREAD GUARD SPECIAL (SGS)

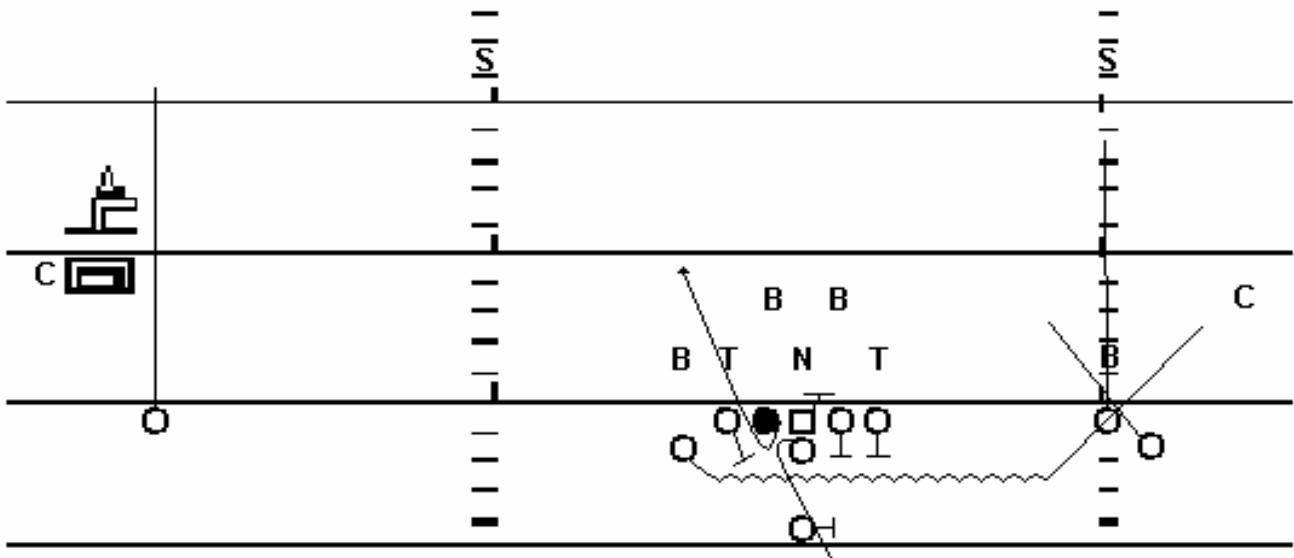

This is (obviously) Coach Bruce Eien's Left Guard Special. Like every other former offensive lineman who coaches, I only wish someone had installed this when I was playing! To paraphrase Coach Eien: Spread Tackle must protect Spread Guard. If anyone is head up or in a 3 shade, ST down blocks and stays on him. If the DT is anywhere on ST he must take away the DT's inside and invite him on an outside pass rush or make him come upfield. If he fights across pressure push him past SG toward flow. Center blocks Bunch side A gap unless there's a 1 shade DT over SG. C and ST must protect SG. Everyone else blocks for a Bunch pass.

SG turns around toward QB and takes the handoff. In doing so, he meets the rule requirements that he be a yard off the LOS and have turned 180 degrees away from it. He bends over like he is sick to his stomach and hides the ball. This is vital, as only the onside DT and LB know where the ball is. The LB sees the handoff but still reacts to the Bunch pass fake. QB then drops normally (although we have also had him fake a "slow" draw like 68). SG waits a full two seconds before he drop steps and heads straight downfield. This pause allows the backside End/LB to come upfield and avoids accidental tackles.

95 RUGBY

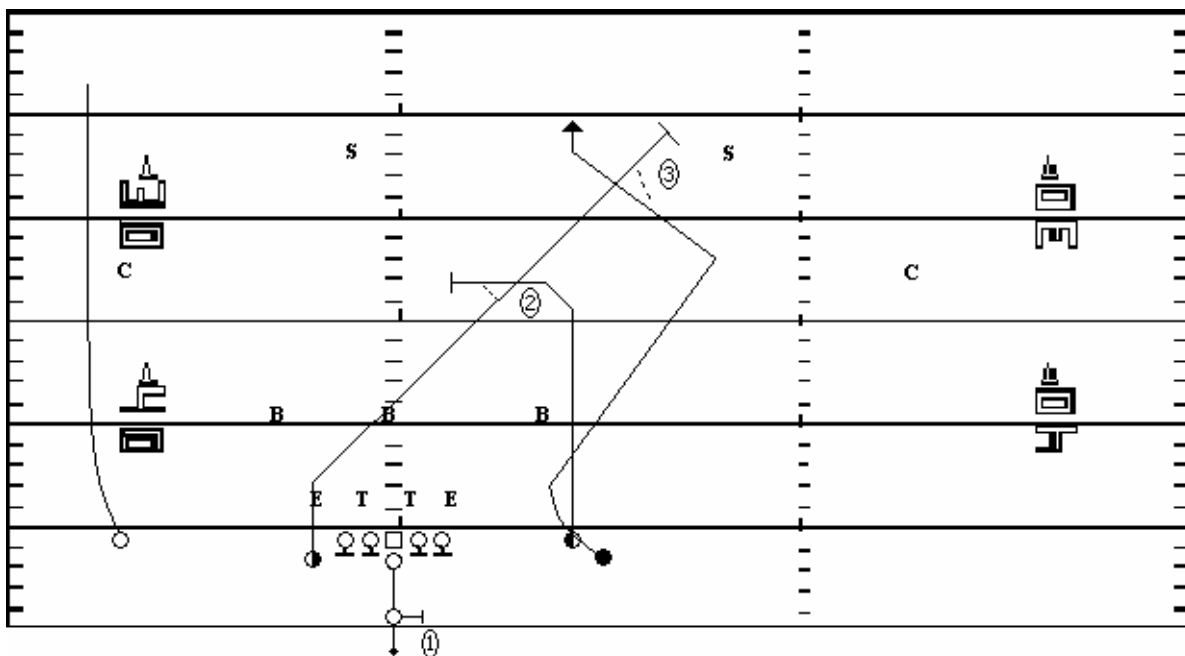

This trick play goes the old hook and ladder one better. This one is for use when it's late in the game and either "third-and-fuggedaboutit" or else the last play of the game - the real "no hope" play when you need six points to tie or win.

The QB takes a five step drop and (1) hits Y's Dig route in between the deep-dropping linebackers. H runs a Slant route and (2) takes a lateral from Y. He then continues outside and downfield, drawing the "prevent" deep backs to him. Z, meanwhile, started up an Inside Vertical route that took him underneath Y, but has drifted back outside and establishes an option pitch relationship with H after the first lateral. Now it's up to H to "option" the most dangerous defender as he heads for the goal line. The longer he can hold the ball, and the more deep defenders he can draw into him before he (3) pitches, the better this play will work. I've diagrammed a sharp cutback by Z before he gets the last lateral, but this depends entirely on how the deep defenders play the two receivers.

97 DOUBLE PASS

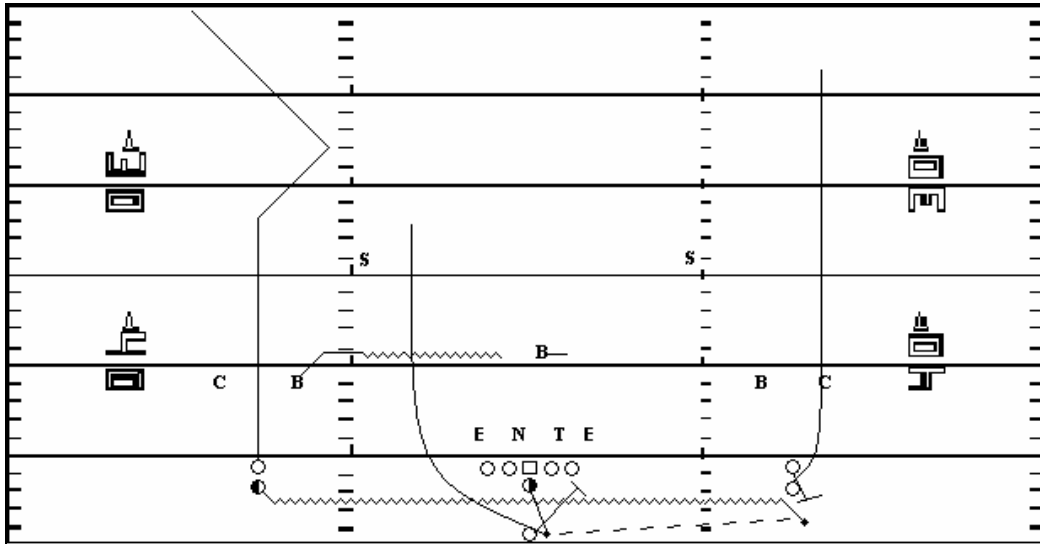

A deceptive play based on 84 Bubble (p. 122). If the defense starts reacting up to the quick bubble screen, we can use H to throw a halfback option pass downfield to a number of receivers (including the QB). The diagram above is a suggestion of the kinds of routes you can run -- actual packages should be game-planned against the kind of coverages you expect to see from 3STACK.

CHAPTER 9: INSTALLATION

I believe that every minute should be accounted for in a practice schedule. There should be evidence of precision in the entire schedule.

Bill Peterson, Building From the Start

If I leave you with only one idea from this chapter, let it be this: when installing an offense, Time is the real enemy. Your best friend, on the other hand, is Organization, as Coach Peterson alluded to in his excellent 1971 book on building a football program (Rice University) from the ground up.

What follows is a layout for a notional 12-day pre-season practice schedule, where four hours a day are devoted to football practice, or a total pre-season of 48 working hours. Many of you will have more time than this to prepare for your next season -- a handful may have less. My intent is to demonstrate that the Wild Bunch can be installed quickly and efficiently IF, as Coach Peterson suggests, you account for every minute. Keep whistles and even air horns handy to move groups between practice segments. I should also add that I try not to do any one thing for more than 15 minutes during football practice. I don't include scrimmaging in that statement, because scrimmaging is, by nature, doing more than one thing. Off the field, I try to hold to a 30-minute maximum for viewing film in groups or as a team -- longer than that, and I believe you are inviting group naps.

Again, however, wasting time is the cardinal sin.

To elaborate on one of the drills mentioned in the figure on the following page: The Fire Hose drills are skeleton backfield drills where the backs go through their running plays using a plastic template that shows where the linemen are positioned. We follow play reps with a special "scoring period" with the fire hose template: after learning the timing of the 10, 20 and 30 series plays from our backfield skeleton drills, our backs are given the opportunity to power their way through air bag holders, high-step over obstacles (blocking bags on the ground), then run 20 yards or more to score -- every time they carry the ball. We always stress scoring whenever we run offensive drills. We want our people to expect to score when they carry the ball -- we want to condition them to "smell the goal line", and what is more, to expect to smell it every time.

PRE-SEASON WILD BUNCH INSTALLATION -- DAY 1

| Pre-Season Practice Schedule: Offense | | | |
|--|----------------------------------|---------------------------------------|--|
| Time | Offensive Line | Receivers | QB/FB |
| 10:00 AM | Cadence/Charge | Passing Lines | Passing Lines |
| 10:05 | | | |
| 10:10 | Block Walk-through (1/2 Line) | Routes vs. Press (X, Y, H & Z) | Ball Drills Fire-hose Drills (Q, F, H & Z) |
| 10:15 | | | |
| 10:20 | | | |
| 10:25 | | | |
| 10:30 | Run Group - A | Pass Group - B | A: Run (H1/Z1) |
| 10:35 | 11, 14 | 50, 51 | B: Pass (H2/Z2) |
| 10:40 | | | |
| 10:45 | Run Group - B | Pass Group - A | A: Pass (H1/Z1) |
| 10:50 | 11, 14 | 50, 51 | B: Run (H2/Z2) |
| 10:55 | (Water) | (Water) | (Water) |
| 11:00 AM | Run Group - A | Pass Group - B | A: Run (H1) |
| 11:05 | 11, 14 | 50, 51 | B: Pass (H2) |
| 11:10 | | | |
| 11:15 | Run Group - B | Pass Group - A | A: Pass (H1) |
| 11:20 | 11, 14 | 50, 51 | B: Run (H2) |
| 11:25 | | | |
| 11:30 | Live 1-on-1 | Outside Drill | Outside Drill |
| 11:35 | 1/2 Line - Thud Plays | 11 | 11 |
| 11:40 | | | |
| 11:45 | Team Offense | Team Offense | Team Offense |
| 11:50 | Line Live | Receivers Live | Backs Thud |
| 11:55 | (With Scout D) | (With Scout D) | (With Scout D) |
| 12:00 PM | Break/Water | Break/Water | Break/Water |
| 12:05 | | | |
| 12:10 | | | |
| 12:15 | Chalktalk | Chalktalk | Chalktalk |
| 12:20 | | | |
| 12:25 | | | |
| 12:30 | With Second (Scout) | With Second (Scout) | With Second (Scout) |
| 12:35 | Defense | Defense | Defense |
| 12:40 | (Installation) | (Installation) | (Installation) |
| 12:45 | With Second (Scout) | With Second (Scout) | With Second (Scout) |
| 12:50 | Defense | Defense | Defense |
| 12:55 | (Installation) | (Installation) | (Installation) |
| 1:00 PM | With First | With First | With First |
| 01:05 | Defense | Defense | Defense |
| 01:10 | (Offensive installation) | (Offensive installation) | (Offensive installation) |
| 01:15 | With First | With First | With First |
| 01:20 | Defense | Defense | Defense |
| 01:25 | (Defensive installation) | (Defensive installation) | (Defensive installation) |
| 01:30 | Kick-off/return | Kick-off/return | Kick-off/return |
| 01:35 | Punt/Block-return | Punt/Block-return | Punt/Block-return |
| 01:40 | FG - block | FG - block | FG - block |
| 01:45 | PAT - block | PAT - block | PAT - block |
| 01:50 | Fake Punt/FG | Fake Punt/FG | Fake Punt/FG |
| 01:55 | Two-Point Conversions | Two-Point Conversions | Two-Point Conversions |

This schedule is designed to install and polish 28 plays in 12 days. The schedule calls for two full offensive and two full defensive platoons, but can be revised to fit any size squad. If you have more than 50 players, it is easy to add depth to the structure to accommodate more bodies. If you only have 15 players, you can break down the training into skeleton backfield and half-line drills. What matters is that you plan things down to the minute.

As charted, the Run Group and Pass Group drills have the two offensive platoons taking turns learning runs and passes, but never more than four total plays a day. I am a firm believer in teaching, repping, polishing, reviewing, and repping and polishing some more. It becomes an integral part of the whole/part/whole teaching process to which I subscribe -- we show the plays on video as a whole; break down the mechanics of each play in small group and team drills; and finally re-construct the whole as an offense by repping and polishing the plays. The latter process occurs in the afternoons during the team installation periods. First the first offense runs our plays against the second/scout D, while at the same time our first D is installing against the second/scout O. Then the first teams come together to work our offensive and defensive schemes against each other.

Day One: We start off on the ground with the Bunch-side Fly Sweep (11) and Dive (14), and in the air with the Seam 3- and 4-verticals route package (50), and the Y Cross package (51). Many concepts and actions are shared between the two runs, which simplifies learning and aids in locking in muscle memory quickly. I try to teach similar plays and/or plays from the same series together whenever possible. The Outside Drill is introduced (actually, we will chalk-talk all drills the night before and show some short, informative video clips of perfect drill execution). In it, backs and receivers work against air bags to establish their blocking assignments, and to practice various blocking techniques (including the downfield release).

Day Two: The next set of plays introduced starts with the Spread-side Fly Sweep (19) and Dive (16), and includes the QB sneak, 32 Wedge. The pass is the classic Run and Shoot "Go" (63) route packages. The Outside Drill adds 19 to the first day's 11.

Day Three: The Rocket Sweep series makes its debut with the Bunch-side Rocket (21) and Belly Sweep (22) plays. The passes are the Rocket Choice (20) and Waggle (26) plays. The Outside Drill focuses on the new Rocket and Belly Sweep plays, having taught and repped the Fly plays the previous two days.

Day Four: The Rocket series nears completion with the Spread-side Rocket (29) and Belly Sweep (28) plays. The passes are the Flag (62) route package and the quick screen to Z, 56 Screen. The Outside Drill reps the Spread-side Rocket and Sweep plays.

Day Five: The Inside Series is introduced with the Inside Zone (36) and Counter Gap (34) plays. The passing game adds the Coverdale/Robinson Mesh route package (74) and the Fly Bootleg (18). The Outside Drill concentrates on plays to the Bunch side -- 11, 21, and 22.

Day Six: The Quick Trap (35) and Rocket Belly (25) plays are introduced -- although the backfield actions are highly dissimilar, the line play is similar. In the air, we introduce the Over (30) play-action route package off the fake of 35 Quick Trap (again, sharing concepts in one session) and the Draw off of 63 Go action (68). The Outside Drill focuses on the Spread side wide plays -- 18, 19, 28, and 29.

Day Seven: The final installation day completes the ground attack with 27 Belly and 1X Slam to round out the Rocket and Fly sweep series. The passes are the 22 Post play-action pass, and the 79 Turn route package. The Outside Drill recaps all the wide plays installed to date: 11, 19, 21, 29, 22, 28, and 18.

Consolidation -- Days 8-12: A colleague of mine once reinforced a key belief of mine on how best to install plays on offense -- Perfect a Few Things First:

"The successful coach I am referring to used to say on the first day of practice that we are putting in our first play. We are not going to put in another until we can execute it perfectly. If we get to the first game and that is only play that we have in, we are going to be the best in the state running that play. Obviously, we went into the first game with more than one play, but it shows the mind set that the program used."

-- Coach Derek Wade, Tomales HS, California.

With that in mind, we never try to install more than four new plays a day; sometimes we have been forced to go even more slowly. If you use whole/part/whole and give your kids quality small group and team instruction, with immediate and appropriate reinforcement all the way, and they STILL don't seem to be picking up your new plays, it may be time to stand back, re-evaluate -- and possibly slow down.

Days 8-12 of the notional pre-season would be devoted to repetition, polish, and some light scrimmaging. I want my kids ready to fire out of the gate from the first whistle of the first game. Chapter 10 details how I get them ready in-season.

PUTTING IT TOGETHER: HOW TO DESIGN YOUR WILD BUNCH

I have been asked a few times to describe the way I put together the Wild Bunch, and it occurs to me that other coaches might want to see that thought process in action. I'll discuss the basic way the various series of plays fit together; then talk about how you can choose plays that best suit your talent; and finally show how the plays relate to each other as sequences, and which plays best complement each other. The intent is to allow you to package together as much useful offense as possible in as few plays -- ideally, in the 35-40 plays that I think is the best size for a Wild Bunch installation for an entire season.

How the jigsaw puzzle fits: The 10 series is the core of the Wild Bunch. The same motion that starts H and Z across the formation looks, for the first few steps, like the motion that forms either Run and Shoot Trips (60 series) or the three-receiver Bunch (70 series). When you run the Fly Sweep and its complementary plays, you are thus introducing an element of uncertainty into defensive thinking (see Chapter 11, page 146). They won't know whether the play will be a Fly series run or play action pass until after the motion back has passed behind the QB -- and with 1X Crash, not even then.

The 20 series stands by itself, since the Rocket motion doesn't look like anything else we do in the Wild Bunch. Within the 20 series, however, every play serves as either a base play (21/29, 22/28), a counter (23, 25, 27), play-action from a base play (20, 22, 26), or play-action from one of the counters (24).

The 30 and 50 series would seem to fit together, since neither involves motion, and in a sense they do. They maintain the classic run-or-pass dichotomy for the defense before the snap, without adding the complications that motion presents. 33 Draw is certainly a complement to the 50 series no-motion passes. However, both the F back runs (35, 36, 34, 38) and the QB Wedge (32) can also be run with motion, especially Z's long motion across the formation that mimics the 60 series (p. 19).

How to feature a stud: If you find yourself blessed with special talent at certain positions, here are some suggestions on how best to feature it.

QB who has:

Speed: Boot him away from run fakes, and he becomes a formidable threat to the defense, forcing them to cover sideline-to-sideline against run-pass dilemmas (18 Boot/Waggle; 26 Waggle; 39 Boot). Or sprint him

out when you pass, and put playside defenders in the same bind (63 Go; 72 Deuce; 10 Flood).

Arm strength: Go deep, young man! Play-action pass route packages almost all have deep routes built in. It is one thing to throw the four verticals pass (50 Seam) against Cover 3 when the defense is expecting a pass (it keeps the attention of defensive coordinators, to be sure). It is quite another to heave it deep after you fake a run that has been gaining consistent yards all day. (17 Dig; 18 Boot; 1X Flood; 26 Waggle; 24 Sluggo; 22 Post; 30 Over; 39 Boot).

F back who has:

Power: If your F back can bust arm tackles without even trying, you definitely want to plan the core of your running game around 35 Quick Trap, 36 Zone, 34 Counter, and the inside complements to the Fly and Rocket Sweep series (14/16 Dive; 25/27 Belly). You should also think about emphasizing play-action off of 35 Trap (30 Over) and 36 Zone (39 Boot).

Speed: 35 Quick Trap is an awesome play if you have a FB who is quick off the mark; if he has blazing speed as well as quickness, he can really tear the heart out of defenses. Otherwise, look at 1X Crash or 1X Slam; 68 Draw; and 58 Statue. The misdirection of the last two plays can help spring a shifty F back into the clear very quickly.

Good Hands: Look at 74 Option Screen, which is a useful way to get the ball in your F back's hands with room to run in front of him, especially if defenses over-shift to the Bunch.

H back with:

Speed: 21 Rocket Sweep, 22 Belly Sweep, 11 Fly Sweep, 15 Triple, and much of the Wild Bunch passing game: 50 Seam, 51 Y Cross, 52 Smash, 80 Now, 62 Flag, 63 Go, 65 In, 74 Mesh, 76 Switch, 78 Quick, and 79 Turn, for starters. A fast H back makes the Wild Bunch go -- if he can also catch the ball, your offense will explode.

Power and agility: If he's really strong, think about moving him to F back. Otherwise, look at 23 Tackle Trap and 1X Truck as ways to feature him on misdirection plays that can cut back sharply.

How the plays best fit together:

The charts on pages 49 and 90 are intended to visually lay out how Wild Bunch plays interlock. Refer to them when you are ready to start building your game plan against a specific opponent. The running game chart on page 49 is especially helpful when planning your deception campaign, in terms of both misdirection on the ground and play-action passes.

I have found that the following pass plays work best together, to help coaches decide which they should carry as part of their 20-25 plays per game Wild Bunch installation. This goes beyond the basic principle that all 50, 60 and 70/80 passes fit together because they share a common type of motion (or lack of motion). Again, see the chart on page 90 for a visual layout of these relationships.

First, 50 Seam, 51 Y Cross and 52 Smash are all useful to combine with 58 Statue, for fairly obvious reasons. (To add a level of deception to your game plan, have X, Y, Z and H base their actions in 58 Statue against a given opponent on whichever of the 50 series passes you will be featuring that week.) Next, both 60 Short and 63 Go fit well together with 68 Draw (if not with each other) for similar reasons.

Finally, 70 Arrow, 74 Mesh, 75 Shallow and 78 Quick all belong together. 74 Mesh and 76 Switch, while not strictly homologous, also work well in combination against Cover 2. The way that you can torment the Bunch-side hash safety by going back and forth between 74 and 76 is almost inhumane. Does he stay close to his hash, even when he sees the 70 series motion that forms the Bunch? Throw the Smash cut to Y from 74 Mesh. Does he start moving out toward his numbers to help cover Y's Smash? Call 76 and throw the ball to Z running right down the hash. Similarly, against any coverage that drops deep when you show 70 motion, call 78 Quick and get the ball out wide to your fastest personnel right now.

CHAPTER 10: THE SITUATIONAL WILD BUNCH

SITUATIONAL PRACTICE: Organization and Attention to Detail are among the coach's best friends in his War Against Time to prepare his team for the football season. The third amigo is Situational Planning. There is not a minute to waste in preparing a football team, and teaching situational football is one of the fastest ways to cut out dead wood from your practice agenda. For example, why work from the middle of the field? That is the easiest place from which to run your plays. For every play you practice from between the hash marks, you should run four or even five plays each from the right and left hashes. Similarly, why practice 1st and 10? Practice 2nd or 3rd and long, or 3rd and 3 (the single most difficult judgment call we are called on to make on a regular basis), or whatever your self-scouting and past statistics show you YOUR crucial situations are.

You have limited time. Your players (at whatever level) need continued work on their fundamentals. Therefore, small group and team drills that teach everyone at once are your most time-effective method to install your offense. And the most effective use of any offensive drill involving backs and receivers, up to and including 11-on-11 drills and scrimmages, is situational planning. Practice your plays from the most crucial down and distance, field position, and time-remaining situations FIRST. Get good at the hard stuff, and work on the other situations if you have the time and nothing more important to do.

So, starting in pre-season, establish habits of excellence and grace under pressure from the very first minute you hit the field. Once you have that Rocket Sweep play learned, get out there and practice it in the tough spots -- from your own 5 yard line on 3rd and 7, for example. Practice your pass plays in "obvious" passing situations, and learn to succeed even when the defense expects what you are doing. (When you get in game situations and start going against those expectations, your players will be thrilled at how easy offense can be, and will gain even more confidence in each other and in your system.)

Situational Game Planning: Do nothing in practice not directly related to your upcoming opponent. I call our in-season practices "Situational Plus." Everything is practiced against down and distance, against field position, against defensive looks, and against time on the clock. Script against more than one of these elements at a time, to save time. Some teams go so far as to have a "46 Bear, 3rd and 7+" play list they work on. I don't take things to those extremes -- but you can bet I will have practiced 3rd and long against an upcoming opponent who plays a 46 defense.

You know what your most effective plays have been in pre-season. You have scouted your first opponent and have some idea what his strengths and weaknesses are. Once you have your scouting report in place, blend it into your situational practice schedule so that your kids know where to expect defenders to line up in every important situation. It's second and short on your opponent's 20 with one minute left in the half. He assumes you are passing the ball, and he will be blitzing. You walk through the situation in practice with your first O against the second/scout D, and you show your kids what is likely to happen, and you spend most of your time working against the likely defensive scheme.

If you get out on the field on game day and the opponent does something completely different, do your kids freak? No -- because you know your game plan and system are sound, and so do your players. You have, among other things in your arsenal, "utility plays" that you know are likely to gain yards against almost any defensive front or coverage, so you practice them as audibles to be ready for the situation where the D completely discards its tendencies and does the totally unexpected. Think 21/29 Rocket Sweep and 20 Choice, as well as 50 Seam, 62 Flag, 63 Go, and 74 Mesh for starters.

Calling the Game/Openers: Know what you want to accomplish. I often script my first 9 plays so that I set the Spread to field three times, set the Bunch to field three times, and run from between the hashmarks three times, once each with motion to Bunch, motion to Spread, and no motion. Why? I want to see defensive reactions to each of those situations. Bill Walsh scripted in even greater detail than that, because he wanted to establish the following things:

- reaction to formations & motion
- probe with base offense - which side of the defense is easiest to run on?
- set up play action and counters
- run your special(s)
- establish sequence for play series
- pre-plan second half openers

3rd and 3: This is, as noted, a bastard of a situation to call the first few times in any game. You want to build your team's confidence, and the Defensive Coordinator is just as intent on shutting you down to deliver a psychological blow. The defense is not playing their short yardage scheme yet, but they will come after you. I try to have three or four runs and three or four passes ready to go to in this situation, and I will script them at the beginning of the game to include other factors such as formation strength and motion. My ready list will always have at least 6

plays to choose from for 3rd and 3, though, so when the time comes to make the call I'm not scratching my head. After the first few series you will have a pretty good idea of what is most effective against your opponent's defense, but those first few 3rd and 3 situations are tough.

My best Wild Bunch calls for 3rd and 3 include:

Runs - pick 3 or 4

35 Quick Trap
36 Zone
34 Counter
21 Rocket Sweep
22/28 Belly Sweep
25/27 Belly
11/19 Fly Sweep
14/16 Dive
1X Slam

Passes - pick 3 or 4

56 Quick Screen
81 Now Screen
60 Short
62 Flag
63 Go
64 Out
74 Mesh
79 Turn
20 Choice

Short Yardage: Now your opponent is in his short yardage D and looking to stop your best running play(s) to your best back(s) -- and if he has played you before, your best pass plays to your best receivers. You want to be mentally prepared for these situations, because if you win the first few, you will establish dominance over the defense -- not all at once (unless you're scoring on every drive), but gradually and inexorably.

I have three runs and three passes ready for short yardage situations, and at least one of those passes will have a "home run shot" built in. This is where coverage tends to be at its most predictable, so 3rd and 1 may be your highest-percentage chance to score with one throw. One of the passes will also be play action from one of our most dependable runs.

Runs - pick 3

22/28 Belly Sweep
25/27 Belly
11/19 Fly
14/16 Dive
1X Crash
36 Zone
37 Lead

Passes - pick 3

79 Turn
52 Smash
39 Boot
17 Dig
74 Mesh
63 Go
64 Out
51 Y Cross

Coming Out/Backed Up: Among other things, this is where you do your full-contact practice work. People need to go full speed to understand what goes on in this part of the field -- the D will be flying to the ball, and the O must strap it on and be ready. You can expect heat through your strongside C gap -- that is where most teams traditionally try to blow up backed-up offenses. So you practice against that.

Working from your own one-foot line to about your own 10, you practice three runs and two passes to use when you are backed up. You can expect the defensive pads to be lower and coming harder down here; linebackers will plug instantly, and wide support (force and alley players) will be up near the line of scrimmage before the snap.

Fortunately, you are running the Wild Bunch, and you have some unfair advantages available. First off, your Rocket and Belly Sweep plays (21/29, 22/28) are no more risky here than any other toss-based play, because you have practiced them under these conditions and your guys know they will move the ball if they follow your game plan. If the defense leaves X room to maneuver once they see Rocket motion, you also have two excellent passes to throw him out near the sideline where the chances of interception are much less -- 20 Choice and 26 Waggle.

Runs

21/29 Rocket Sweep
22/28 Belly Sweep
11/19 Fly
18 Waggle (NOT the naked 18 Boot)
27 Belly
1X Truck

Passes

20 Choice
26 Waggle
60 Short
51 Y Cross
79 Turn
64 Out

Red Zone: Homer Smith has some very strong ideas about Red Zone offense:

"In what is called the red zone, defenses change according to the distance of the line-of-scrimmage from the end line. The red zone is a zone of changing pressures by the defense. It is a zone of changing needs by the offense, a zone where distances to the end line must be considered along with distances to the first down line."

Here are some offensive considerations in the red zone:

"As the defense has less and less depth to defend, the offense must have more and more lateral faking and running."

Hel-LO Fly Sweep series! Fake in both directions and up the middle, with play-action available in several flavors. The defense must race to both sidelines to cover all the threats, but can't neglect your spread receivers -- are they blocking, or...?

"As the length of the field can be used less and less, the width of the field must be used more and more."

Fly, Rocket, Sweep, Choice (to take advantage of what depth there is, as the defense reacts to Rocket motion). Short and Turn. Out can be lethal against man coverage.

"As pass routes get to the end line faster, the quarterback's delivery of the ball must be sooner."

Quick passes are a must -- 78 Quick, 79 Turn, 64 Out. Also play-action that moves the pocket and makes the QB a lateral running threat -- 18 Waggle, 26 Waggle, 39 Boot, 1X Flood.

"As less field means higher field goal percentages, it also means more full-pressure defenses and more plays that discourage full-pressure defenses."

21/29 Rocket Sweep, 22/28 Belly Sweep, 56 Quick Screen, 80 Now Screen -- plays that will pop the ball carrier into the clear even faster if the defense brings pressure.

"As less field means more concentrated pass coverage, the more costly it is to give the coverage one-for-one trades, the more costly it is to let one defender take one receiver out of the game."

This is where the Bunch concept comes into its own. Teams that try to defend your Bunch with three defenders are going to get beaten. You make them commit 4 defenders to your 3-receiver Bunch, and then you have options all over the field. 74 Mesh if they play you head up, 74 Option Screen if they overplay to Bunch. 79 Turn to get the ball outside immediately, and 72 Deuce when you're inside the 5.

There will always be an unblocked defender on defense -- how well you identify him and plan to defeat him will have a lot to do with how often you score, especially down in the Red Zone. You can't pound on him by definition, so you had better find a way to deceive him. As a coach once noted, a faking back will keep a defender away from the ball carrier more efficiently than if he blocked him.

Goal Line: Expect versatile defensive pressure on the 3 yard line -- out-slanting charges, free safeties re-inserted into the secondary, etc. Down on the one-foot line, however, it's pure gap charges and man coverage. You must practice these situations every week, if not every day, and you must instill your attack philosophy in your team so thoroughly that they will never lose their poise down close to the goal line. There is a great deal to be said for tossing the ball to your fastest back and letting him run for the pylon, by the way -- 28 Belly Sweep and 29 Rocket Sweep.

Runs

28 Belly Sweep
29 Rocket Sweep
11/19 Fly
1X Crash
1X Slam
37 Lead

Passes

79 Turn
72 Deuce
18 Waggle

DEFENSIVE FRONTS: I won't try to make this comprehensive, but obviously I believe it is easier to run outside on a loaded 8-man front that has most of its strength concentrated between the offensive tackles. I will go so far as to say that with the Fly and Rocket Sweep series at my disposal, I will get defenses out of 8 man fronts pretty darned quick. Double Eagle fronts in particular are begging to be Rocketed. If you have success with the outside game, I believe, it will make gains with plays like 25 and 27 Belly even more devastating to defensive morale and cohesion.

BLITZ SCHEMES: This is more of a philosophical consideration than a play-by-play discussion. First off -- why do teams blitz? Because they think their pressure will blow up run-blocking schemes and spook quarterbacks into throwing the ball away or getting sacked. What does the Wild Bunch offer against such a strategy? Several things -- the spread of the formation and the constant use of motion make it extremely hard to disguise blitzes. Most pressure-oriented teams will therefore show a lot of blitz, then back off at times and come at times.

What kind of coverage will they play behind their blitz? If it's man, we have some answers, both in the form of built-in Q routes in some of our favorite packages (Mesh, Sluggo, Dig), and in our MAX-protect scheme (Hinge, Wrap, Twist). 64 Out can kill the man blitz if you can regularly hit either of the quick Outs.

The zone blitz is a completely different kettle of fish, of course, and it is designed to panic QB's into breaking off to throw hot reads right into the hands of dropping defensive linemen. Where is the real threat of interceptions coming from with the zone blitz? Inside, of course -- not too many DE's (much less DT's) can drop and cover the flats after drawing a block first.

Which suggests a plan of attack against teams that you know favor the zone blitz -- lots of quick passes to the flats (Short, Turn, Go, Out), as well as 5-step drop route packages that have flat routes built in -- Mesh, Switch, Y Cross.

And (surprise) run the ball wide! Make them chase down the Rocket/Belly Sweep/Fly man. Call those plays in "sure" passing

situations. Then call play action off them in the same situations later in the game.

All of which folds back into my life-long motto, "Keep 'Em Guessing." In the final chapter, I will explore why it is so important to keep your opponent off balance, mentally as well as physically.

CHAPTER 11: A PHILOSOPHY OF ATTACK



Herakles and Alcyoneus

The big naked guy is Alcyoneus, a giant who once battled Herakles (the one wearing the skin of a lion he killed bare-handed --you know him as Hercules) to a draw by using magical powers. It seems when Herakles shot the giant with an arrow, Alcyoneus fell to the ground -- but then sprang up, revived. Even after delivering punishment that would have killed a hundred ordinary men, Herakles was no closer to winning the fight. Then fortune entered the battle in the form of Athena, goddess of wisdom. She told Herakles that Alcyoneus had a little secret -- on his native soil, he was literally invincible. Herc (er, Herak) thought for a minute, then picked Alcyoneus up in a bear-hug, and calmly carried him to the nearby land of Boeotia. Once there, he put Alcyoneus down and beat him to death.

When I completed my M.S. in Strategic Intelligence from the Joint Military Intelligence College in 1998, I was left with a collection of very interesting books in my home library. They dealt with everything from military strategy to the practice of modern intelligence. When I started this chapter, I had an idea that I could find a theoretical basis for the Wild Bunch somewhere in that stack of books. As it turned out, I was right, but not in the way I thought.

I was convinced at first that the area that would yield the quickest results was maneuver warfare -- concepts as old as Genghis Khan that have lethal applications on the 21st Century battlefield. And I was right -- the Alcyoneus Principle is a key thesis of LTC Robert Leonhard (USA, ret.) in his excellent The Art of Maneuver. Leonhard's idea is as basic and to the point as Herakles's method for dispatching Alcyoneus. Don't slug it out with the enemy at what he does best, on the territory where he does it best. In short, take the giant away from his homeland and kill him.

Does this concept have implications for football? I think so. (And before anyone starts thinking that I am one of those fools who subscribes to the "football is war" school of thought, rest assured. I can tell the difference between war and a war game -- but I will argue until the cows come home that football IS a war game, as much as or more than chess or Go.)

The conceptual use I have for the Alcyoneus Principle on the gridiron is this -- don't take on your opponent at what he does best or where he is most concentrated. Coach Woody Hayes put it very well, misquoting Sun Tzu slightly, but to good effect: "Don't attack walled cities." I would add to that a corollary -- don't attack walled cities while the defenders are fresh and alert. Maneuver past the concentrations of enemy forces into open territory and ride like hell. Force your opponent to re-deploy his forces to cover more ground, until you have him stretched thin from sideline to sideline. THEN attack the walled city, while its defenders are out in the plains waiting for a cavalry end run that never comes.

Bill Walsh expressed this theme very well. While at Stanford the first time in 1977-78, he had fair talent, good speed and great skills, but not enough beef to slug it out with USC or Oklahoma, both of whom he faced twice. His solution was to design an offense (the since-maligned West Coast Offense, which was simply ball-control passing from a pro set) that took advantage of his players' skills and allowed them to slay the giant more than once. He didn't want to have to push USC into the end zone from the 3 yard line -- he wanted to throw a play action pass on USC's 20 and have his receiver get chased into the end zone by a defensive back.

(I would offer a caution to those of you who want to make this your Red Zone strategy from now on -- there is one important potential exception to the Alcyoneus Principle. All other things being equal, I would argue that the simplest solution is the best near the goal line. If you are close enough in strength to your opponent to have a better-than-even chance of pushing the ball in from 1st and goal on the 3, even if it takes you two attempts, then push it in -- the Red Zone is no place to get cute and outthink yourself. If, on the other hand, you are at a severe strength and size disadvantage, then by all means opt to have defenders chase

you into the end zone. Happily, the Rocket/Sweep/Fly elements of the Wild Bunch allow you several ways to get chased into the end zone without much thinking involved at all.)

Leonhard went on to apply the Alcyoneus Principle to combined-arms warfare:

"Divest the enemy of one of his capabilities, then exploit that weakness."

This has a familiar defensive application in football -- win 1st and 2nd down by committing to stop the run, then take away the pass on 3rd down. I believe there is an offensive side to that coin, however. If you have installed an integrated offense that can attack with speed, power and deception, on the ground and in the air (as John Madden might say, "Hey, wait a minute -- that's the Wild Bunch!"), you can take away the opponent's ability to stop the run on 1st and 2nd down. Once that happens, all your paths are open. Any fool can pound the rock up the middle -- the talent comes in convincing defenders to vacate the middle BEFORE you pound the rock.

All of which leads me to my real discovery. As nicely stated as Leonhard's thesis is, and as useful for shaking up military traditionalists, it felt incomplete as a guide to football strategy. Where I struck gold was in a completely different field -- strategic intelligence, and particularly Warning and Indicator (W&I) intelligence. The link was another Sun Tzu quote that tied in very nicely with Homer Smith's observation about deception: "Warfare is the Way (*Tao*) of deception."

("Tao", pronounced "Dow", means "Way" in a perfect sense -- not just The Way, but The Perfect Way. It is also ultimately knowable only through wordless understanding after long study -- "The Tao which can be spoken is not the true Tao." In this sense, Sun Tzu argues that warfare -- and, I suggest, the wargame of American football -- can only be mastered by those with a perfect understanding of deception.)

What is the purpose of deceiving your opponent in football? I believe it is to force him to be slow and reactive in everything he does, while he sorts out which of your options will come true on any given play. It is, ultimately, to force your opposite number outside of your Observation-Orientation-Decision-Action cycle (otherwise known as the "OODA Loop" of the late Col. John Boyd, USAF).

Colonel Boyd believed that the side in a conflict which could assess the situation and respond both correctly and in less time than its opponent would ultimately win. He had a specific goal in mind:

"Collapse [the] adversary's system into *confusion* and *disorder* by causing him to over- and under-react to activity that appears simultaneously *menacing* as well as *ambiguous, chaotic, or misleading*. [This will induce] various combinations of uncertainty, doubt, confusion, self-deception, indecision, fear, panic, discouragement, and despair."

(John Boyd, A Discourse on Winning and Losing: Patterns of Conflict, Unpublished briefing, December 1986, slide 7; emphasis in original)

(Be aware: We are talking about a concept which is designed not only to help you win, but to reduce your opponents to a state of despair. I do not find anything "unsportsmanlike" about this, but it can potentially lead to unhappy consequences if, having backed an opponent into a psychological corner, you continue to push.)

OH, WHAT A TANGLED WEB WE WEAVE...

In any event, the Sun Tzu quote got me thinking along two lines -- one, there might be some useful general theory out there about deception; and two, there were probably all kinds of practical applications of this concept in football.

As it turned out, the W&I literature was an absolute jackpot. A team of authors from Sandia National Laboratories framed things perfectly:

It seems to us at this time that there are only two ways of defeating an enemy:

- 1) One way is to have overwhelming force of some sort;
- 2) The other is to manipulate the enemy into reduced effectiveness -- induced misperceptions that cause him to misuse his capabilities.

(A Framework For Deception, Cohen, Lambert, Preston, Berry, Stewart & Thomas: <http://www.all.net/journal/deception/Framework/Framework.html>)

BINGO! Sound familiar, Bill Walsh? But it got even better: there are two generally recognized types of deception: Ambiguity (A) and Misleading (M) deception (which is also known as misdirection -- better and better). A-type deception attempts to fool a defender by increasing the number of options he has to worry about. It increases his uncertainty about the offense's eventual course of action by offering more than one alternative, causing the defender to "spread resources thinly to cover all important contingencies." ("Strategic Military Deception", Katherine Herbig and Donald Daniel, in Strategic Intelligence: Theory and Application, Joint Military Intelligence Training Center: Washington DC, 1995.)

M-type deception, on the other hand, decreases uncertainty by convincing the defender that one of your lies is true. He focuses on your misdirection deception, and makes himself, as one scholar said of Stalin anticipating an ultimatum from Hitler before he attacked Russia, "quite certain, very decisive, and wrong." (Hitler, of course, attacked the Soviet Union without warning in 1941.)

How does this relate to the Wild Bunch? I believe A-type deception applies to the Wild Bunch through the multiple threats which stem from one basic formation and one basic type of motion (and here I'm focusing on the 10, 60, 70 and 80 series). As I noted in the first edition of this work, "Neither when we come up to the LOS, nor after we send a receiver in motion, can the defense over-commit to stop a particular threat."

Uncertainty, and thus A-type deception, is at its peak before the ball is snapped. Let's say Z goes in motion across the formation. The middle linebacker notes this, but is uncertain of how to respond at first. Will the ball be snapped when Z is still outside Bunch Tackle for the 62 Flag pass route package? Will Z get the ball on the midline and run 19 Fly? Will he receive a fake, and the ball be handed to F on 16 Dive? Will H receive a hand-off in the opposite direction for 1X Truck? Will a play-action pass (17 Dig) or even an option play (15 Triple) break out? Or will Z continue on his motion path for a 60 series pass? Or, finally, will Z motion out wide, only to see the ball handed to the F back on 68 Draw, or any of the 30 series Inside plays -- 36 Zone, 35 Trap, 34 Counter, or 38 Ice? Now THAT'S ambiguity.

M-type deception, in turn, peaks after the snap. Now we see H go in Fly motion, and the 11 Fly/14 Dive/18 Boot sequence is executed. Where is the ball? If the offense can condition the defense to expect one answer to that question, and then deliver another, that is misdirection.

The Fly series thus has both strong A-type and strong M-type deception. Those two qualities make the Fly Sweep the glue that holds the Wild Bunch together. The Rocket Sweep series, on the other hand, involves rather less A-type deception. Rocket motion usually means one thing is coming -- a quick toss to a full-speed back who will take the ball wide to gain yardage. Other things can and do happen, but they are very much subsidiary to the Sweep.

Where the Rocket series excels, I believe, is in M-type deception -- not because of elaborate faking (it is always harder to fake a toss convincingly than to fake a hand-off), but because of the Rocket's sheer, unstoppable SPEED. The defense is forced to decide RIGHT NOW where the ball is going, and must commit in many cases before it is positive

who is holding the pigskin. I have seen the results on cut-up films from Wofford College, and on televised Navy games from 2003-2005 -- the defense will always be wrong unless it has overwhelmingly superior personnel -- faster AND stronger across the board. Even then, I would want to be running the Rocket series on offense, knowing it and the intricate, multi-dimensional Wild Bunch passing game gave me a fighting chance.

APPLYING STRATEGY TO FOOTBALL

A few final words on offensive strategy for football in general, but especially as it applies to the Wild Bunch:

1) **Don't Fight Fair!** Strength-on-strength contests always, only go to the strong -- and they tend to exhaust even the strongest. Instead, focus your strength on your opponent's weakness:

- If his strength is lateral speed, attack him head-on
- If his strength is mass, outflank him and take him deep
- If his strength is mass AND speed, open your bag of tricks -- deceive him to lead his pursuit astray, spread him to negate his mass advantage

2) Disguise your weaknesses. If you can't throw deep, throw enough play-action passes at your opponent to keep him off balance. Move the pocket with action passes to keep pass rushers off balance and to bring your QB closer to his receivers. Feature the short pass, but build deep passing routes into your ball-control packages -- in short, replicate what Bill Walsh did out of necessity with the Cincinnati Bengals in the 1970's.

If you can't run the ball inside (small, weak, inexperienced line, or ineffective backs), run the ball wide (Rocket Sweep series), throw action passes that make your QB a run/pass threat on the defensive flank, and throw play-action off your wide run threats.

If you can't run or pass, don't give up hope -- it's never too late to start coaching soccer...

(Seriously, you need certain basic qualities to run the Wild Bunch, but it IS adaptable to talent.)

3) The Wild Bunch lends itself to strategic analysis -- its weapons interlock, suggesting tactics instantly based on defensive reactions. You don't have to reach into a "grab bag" of plays and hope the one you pull out will work.

- Attack the flanks first -- Sweeps, Bootlegs, passes to the flats
- Have a vertical threat built in to your ball-control passes to keep the secondary deep
- When the defense widens to counter your first threats, run inside
- If they start off wide (as the result of scouting your previous games), begin your attack inside
- Have good play-action route packages for every major run play -- if the secondary comes up to stop the run, throw over their heads

4) Use a "toolbox" approach (as espoused by Coach Bill Cronin of Georgetown College in Kentucky). Have a tool for every defensive problem/coverage/front/blitz package that you can reasonably expect to face. Do this planning well before the season starts and you will keep surprises to a minimum.

5) Focus on the outcome, not the methods. Too often we become so caught up in how we are doing things that we forget the ultimate goal -- we allow process to take on a life of its own. Of course we seek excellence in training to defeat our enemies -- who doesn't yearn for that elusive "perfect practice"? But never forget -- it is the end result that matters, not how prettily we can practice.

Why is this important? Too often I have seen coaches get caught up by the "laundry list" approach to preparation -- they reduce their plans to a series of activities to be checked off before the season or the big game, as though checking off boxes will in itself beat the other team. Realize this -- preparation for combat is important, even vital -- but it is not combat. Checking off a "laundry list" of things that need to be prepared for has never won a football game.

An illustration: The great swordsman and combat theorist Miyamoto Musashi was undefeated in duels, often against opponents who dedicated their time to the forms and rituals of Kendo, Japan's sport of sword-fighting. Musashi, on the other hand, merely fought:

In Edo, a fighter named Muso Gonosuke visited Musashi requesting a duel. Musashi was cutting wood to make a bow, and granting Gonosuke's request stood up intending to use the slender wand he was cutting as a sword. Gonosuke made a fierce attack, but Musashi stepped straight in and banged him on the head. Gonosuke went away.

Musashi is an excellent exponent of the concept I am trying to get across here. He faced swordsman after swordsman, all well-versed in the subtle arts of Kendo, all immaculately robed and prepared for combat. Musashi himself never bathed or cut his hair, afraid that he would be vulnerable to surprise attacks in the bath or at the barber. However, he never stopped studying the art of sword-fighting, and he never stopped

training -- he just never confused preparation for combat with actual combat. Time and again Japan's best swordsmen fought this unkempt, smelly loner, and time and again he beat them senseless or left them dead.

In football, it is essential to focus on what matters most -- defeating the enemy quickly and cheaply (in terms of time and energy expended). Not how nice your uniforms look, or how many people pass through the turnstiles at your home games. Your preparations are important, but remember your plans can be dashed in an instant when your star QB goes down with a knee injury. Truly great coaches focus on defeating the enemy in a way that takes these unpleasant facts into account:

- Personnel availability (health, grades, etc.)
- Conditions (weather, officiating, etc.)
- Position in season -- you may decide to save some things for later

Given that your careful preparations can be undone very quickly, it is best to focus on the mechanics of perfecting the tools that will actually defeat your opponents, then deciding how best to employ them in the moment. This philosophy should help you hone your practice schedules to a very fine edge. Eliminate everything that is not absolutely essential to the actual defeat of upcoming opponents. Now go back and re-read that. Then re-read it again. Now act on it.

Finally, finally: I believe coaching is a calling. You either get it or you don't. There are times when you may question the time, energy, and emotional output that you devote to football. You may wonder whether you will ever get back everything out of coaching that you put into it. Anyone who has cleaned up after a three-hour practice in cold rain and mud can be forgiven for believing that the universe is eventually destined for a cold, dark coda.

Of course, football sometimes violates the First Law of Thermodynamics, in that it is possible to get more back from football than you put in -- in fact, it happens all the time. I cannot express how much it means to me that several of my former players have themselves become football coaches, for example.

Those of us who believe in an all-powerful, all-knowing, ever-present, loving God have no problem whatsoever with this concept. It is to Him that all praise is due, for football and for the other tools He uses to instruct us.

THE PSYCHOLOGY OF FOOTBALL VICTORY

I think coaches would do well to locate a copy of The Development and Control of Behavior in Sport and Physical Education by Brent Rushall and Daryl Siedentop (Lea & Febiger: Philadelphia, 1972.) Long out of print, this book is occasionally available on Internet sites such as www.ABEbooks.com. You'll notice the title uses the word "control" -- something modern educators will probably shudder to see. Rushall and Siedentop are students of the behavioral psychologist B.F. Skinner, and apply his theories of Operant Conditioning to sports and physical education. To distill their arguments as much as humanly possible and still retain any of their insights, there are two things every coach and physical educator needs to understand:

1) If you want to increase the frequency and strength of a particular behavior, whether it be "executing a trap block" or "not picking one's nose", you positively reinforce that behavior -- always positive, always looking for something to praise, always pointing out successes on the spot. With behaviors you want to get rid of (or "extinguish", as Skinner said), you have several options. You can ignore the behavior until it eventually dies of boredom, or you can call attention to it, but in a team-positive manner - "C'mon, Joey, let's stop horsing around and act like a Titan".

2) Punishment, they note, can extinguish unwanted behaviors very rapidly, but it often has unanticipated consequences. To be effective, punishment should also be delivered as soon as possible after the undesirable behavior is emitted -- preferably right on the spot. Punishment also has to be relatively more severe than whatever positive reinforcement the individual is receiving from the unwanted behavior. When punishment passes a certain level of severity, however, it elicits aggression from the one being punished -- long-lasting hatred can result from a thoughtless over-application of punishment, even one as "harmless" as public ridicule.

Rushall and Siedentop explain why positive reinforcement is more effective -- not for any touchy-feely reasons, but because conditioning is a scientific fact, and the most efficient way to shape human behavior when properly used. Positive reinforcers motivate all of us, without the risks inherent in punishment and humiliation.

In closing: As noted earlier, questions about Wild Bunch, or requests for copies of my SORS (p. 5), and/or Modern TCU Spread (p. 7) playbooks may be sent to: seayee@hotmail.com

SPECIAL NOTE: Many thanks to Coach Marcel Seidel of the Niederrhein Psychos (possibly the best team name in all of football) in Germany, and Coach Jim Teahan of the Alta Hawks in Utah, for their kind permission to use the game photos which appear in this book.

It is both flattering and gratifying that people want to draw on something we've done and put their own twist on it; this process is the very lifeblood of football, and it's what we intended for the books all along.

You've done some very good things in packaging the Wild Bunch together. We, too, have discovered the impact of the Fly Sweep series and have used it to good effect in a lot of ways. We played around with your "Max Twist" route with some success last year as well, having stolen it ourselves from Rams film.

Andrew Coverdale, May 2002

Thanks for the document. It is a well done playbook. Research is impressive.

Mark Speckman, July 2004

Now let me spend a minute in going back to the final chapter of The Wild Bunch. What you have done here is create a document about the principles that govern offensive strategy. Your approach is innovative but sound. In my career I've tried to do the same thing "walking a different road." But our overall approach is much the same.

Again, I congratulate you on a superb job!

Dr. Kenneth Keuffel, July 2004



Ted Seay started coaching football while still playing the game as a high school junior in 1974. From his original experience coaching both Police Athletic League and girls' flag football teams (made possible through his discovery of Dr. Kenneth Keuffel's monumental Simplified Single Wing Football in San Francisco's main public library), he has gone on to coach high school, club and university teams in the U.S. and overseas.

A failure at stand-up comedy, Seay joined the Foreign Service in 1985 and has since served in Mexico, Australia, Jamaica, Slovenia, Fiji, and Austria, as well as several tours of duty at the Department of State in Washington, D.C. When not posted to a country where they play American football, he works to update his knowledge of the game, and to share ideas with other coaches on the Internet. His concepts are featured on <http://forums.delphiforums.com/TedSeay>

Divorced, overweight and childless, Seay enjoys reading, especially military history, as well as hiking, snorkeling, and playing cricket, albeit very badly. Although his interview with the late Michael Manley was published in *Wisden Cricket Monthly* in April 1995, Seay's claims to understand the LBW law are seldom heard and generally disbelieved.