

PASS PROTECTIONS

20 (21) PROTECTION

Assignments: (5-7 Step Drop Back)

TE – Release

RT – Big Man – “Big” call MDM vs. 43 (20)

RG – Covered – Big Man Uncovered – “Ace” call

C – Covered – Big Man Uncovered – “Ace” call

LG – Covered – Big Man Uncovered – “Ace” call

LT – Big Man – MDM vs. 46 (21)

FB – Outside LB Alert – “Alert” call

HB – Free Release.

43 Over

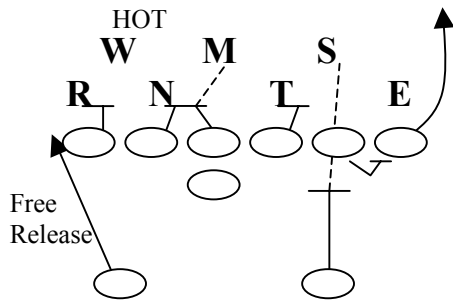

43 Under

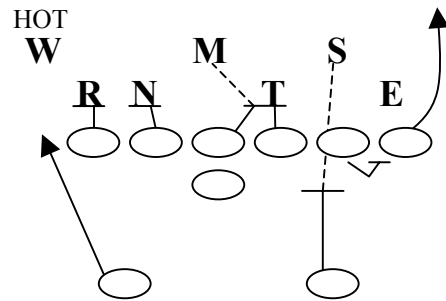

54

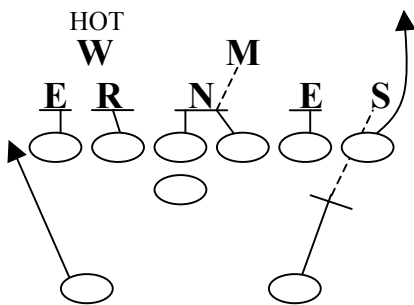

55 Over

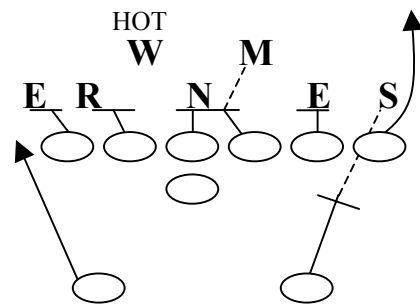

64 Over

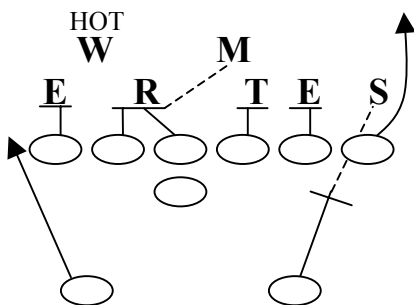

64 Under

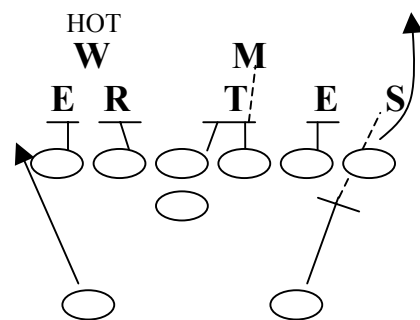

22 (23) PROTECTION

Assignments: (5-7 Step – Drop Back)

TE – Release

RT – Big Man – “Big” call MDM vs. 43 (22)

RG – Covered – Big Man Uncovered – “Ace” call

C – Covered – Big Man Uncovered – “Ace” call

LG – Covered – Big Man Uncovered – “Ace” call

LT – Big Man – MDM vs. 46 (23)

FB – Outside LB Alert – “Alert” call

HB – Free Release

QB – Hot off Outside Backer, If 3 Technique hot off anyone strong side.

43 Over

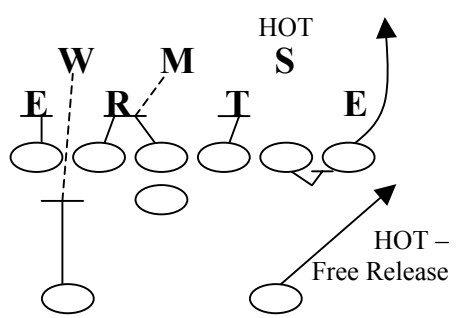

43 Under

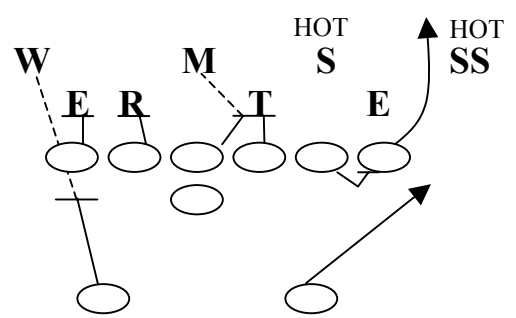

54

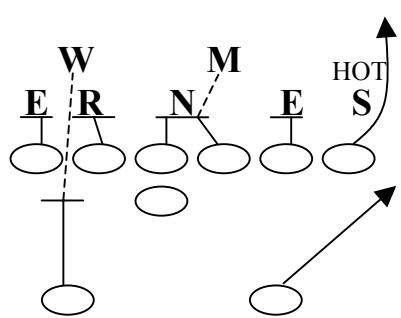

55 Over

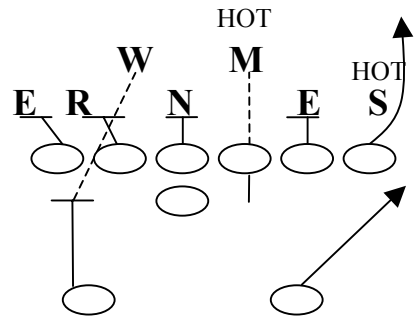

64 Over

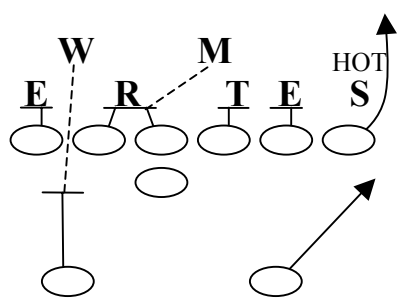

64 Under

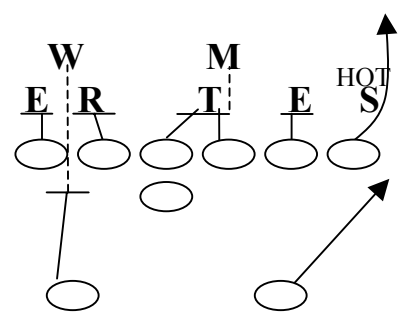

322 (323) PROTECTION

Assignments: (1-3 Step Drop – Firm)

TE – Release

RT – Big Man – “Big” call MDM vs. 43 (22)

RG – Covered – Big Man Uncovered – “Ace” call

C – Covered – Big Man Uncovered – “Ace” call

LG – Covered – Big Man Uncovered – “Ace” call

LT – Big Man – MDM vs. 46 (23)

FB – Outside LB Alert – “Alert” call

HB – Free Release

QB – Hot off Outside Backer, If 3 Technique hot off anyone strong side.

43 Over

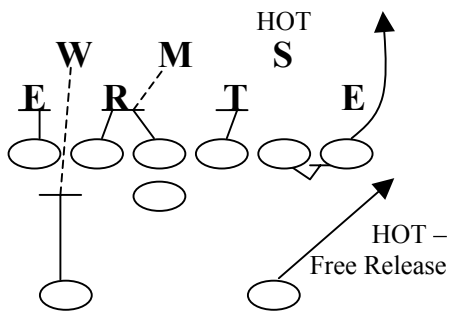

43 Under

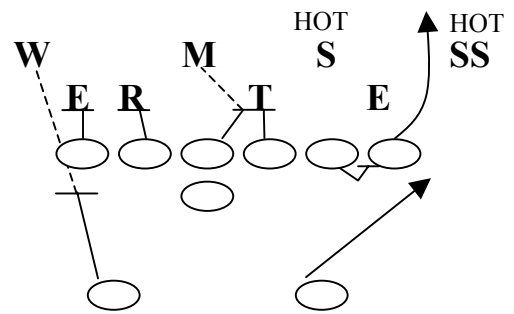

54

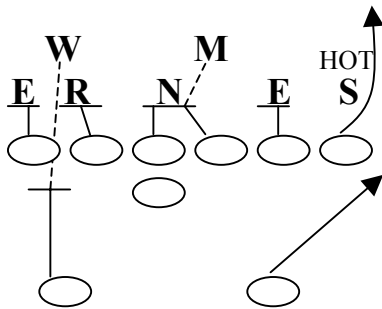

55 Over

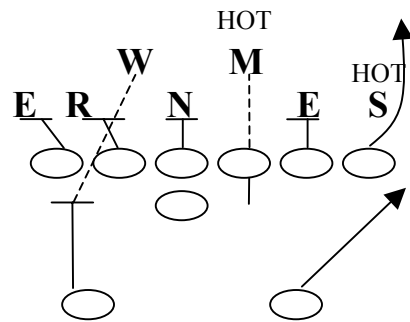

64 Over

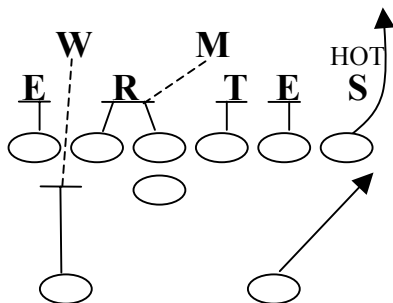

64 Under

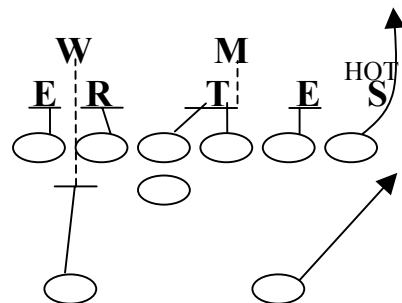

24 (25) PROTECTION

Assignments: (5-7 Step – Drop Back)

TE – Release

RT – Big Man – “Big” call MDM vs. 43 (24)

RG – Covered – Big Man Uncovered – “Ace” call

C – Covered – Big Man Uncovered – “Ace” call

LG – Covered – Big Man Uncovered – “Ace” call

LT – Big Man – MDM vs. 46 (25)

FB – Outside LB Alert – “Alert” call

HB – Outside LB Alert – “Alert” call

43 Over

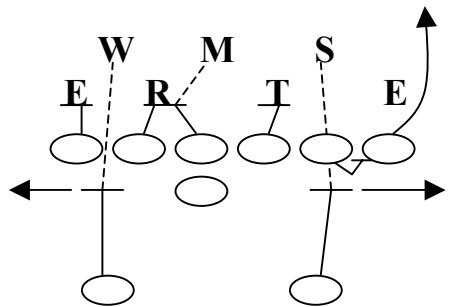

43 Under

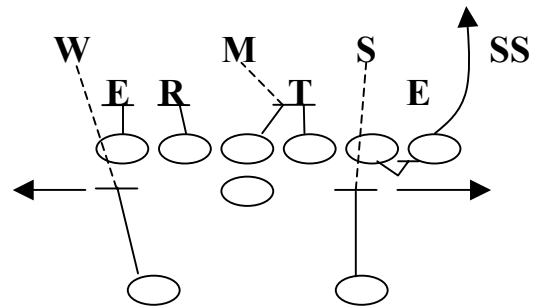

54

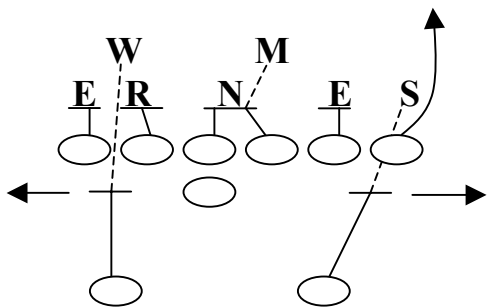

55 Over

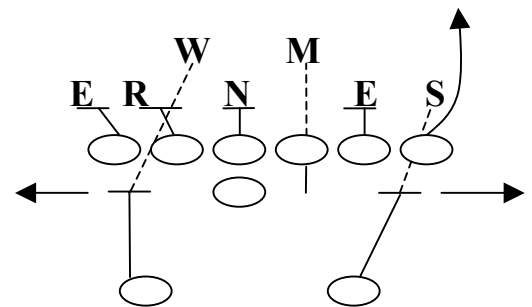

64 Over

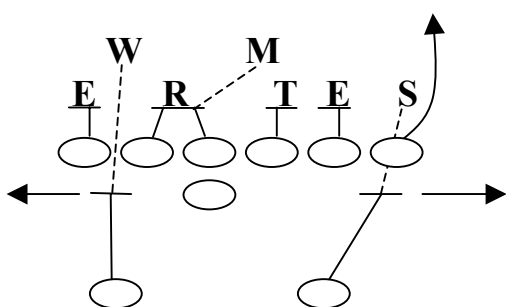

64 Under

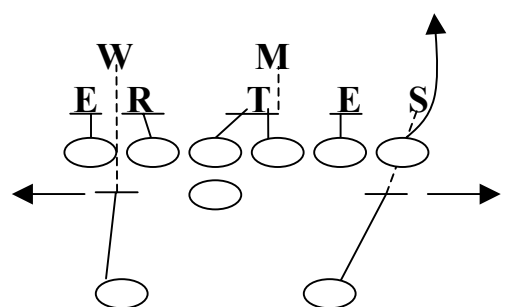

324 (325) PROTECTION

Assignments: (1-3 Step – Firm)

TE – Release

RT – Big Man – “Big” call MDM vs. 43 (24)

RG – Covered – Big Man Uncovered – “Ace” call

C – Covered – Big Man Uncovered – “Ace” call

LG – Covered – Big Man Uncovered – “Ace” call

LT – Big Man – MDM vs. 46 (25)

FB – Outside LB Alert – “Alert” call

HB – Outside LB Alert – “Alert” call

43 Over

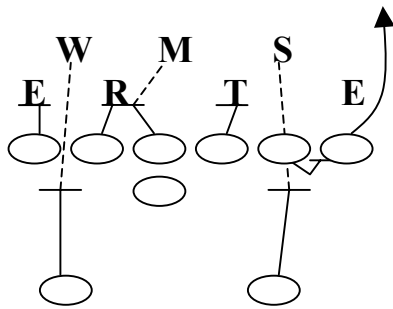

43 Under

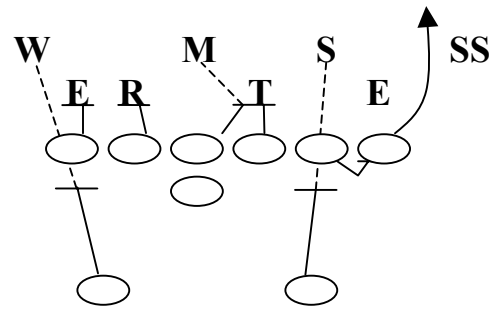

54

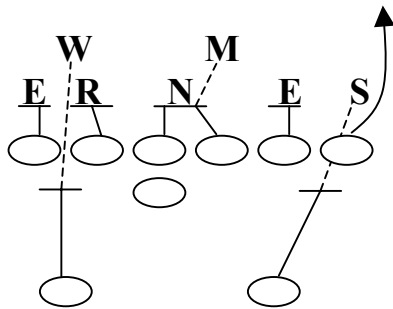

55 Over

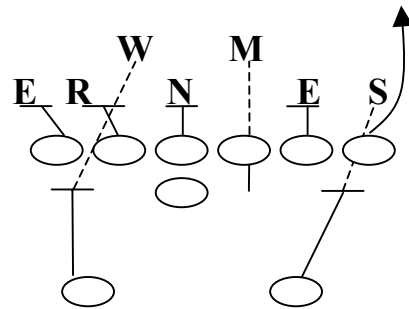

64 Over

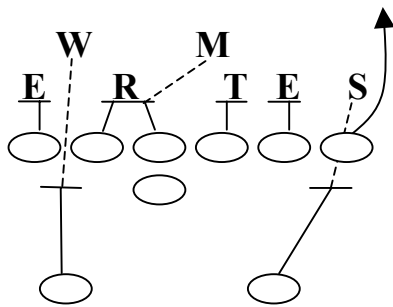

64 Under

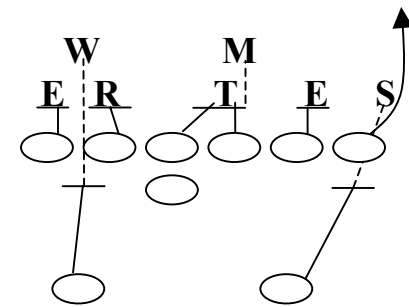

74 (75) PROTECTION

Assignments: (5-7 Step – Drop Back)

TE – Big Man – “Fan” vs. Nickel

RT – Big Man – “Big” call MDM vs. 43 (74)

RG – Covered – Big Man Uncovered – “Ace” call

C – Covered – Big Man Uncovered – “Ace” call

LG – Covered – Big Man

LT – Big Man – MDM vs. 43 (75)

FB – Outside LB away from call Roger to “Alert” call

HB – Free Release Weak

43 Over

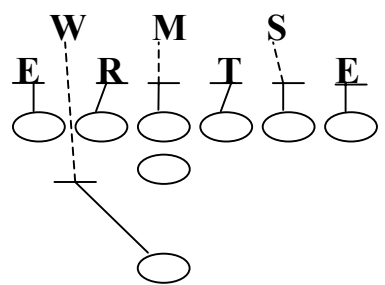

43 Under

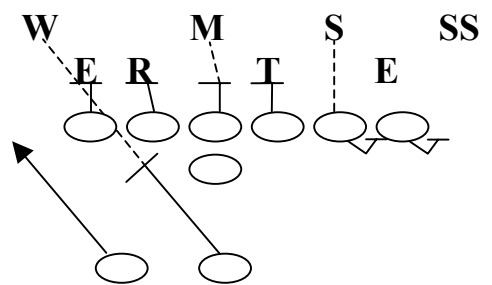

54

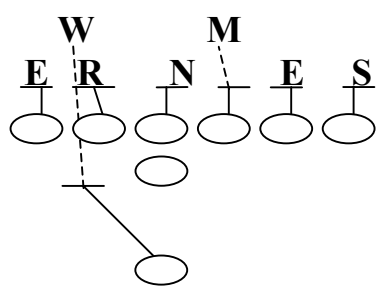

55 Over

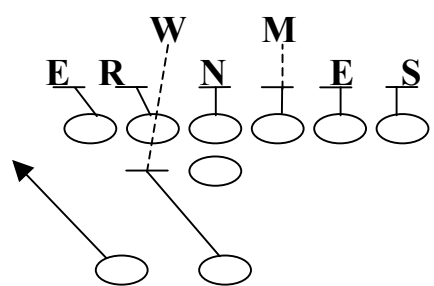

64 Over

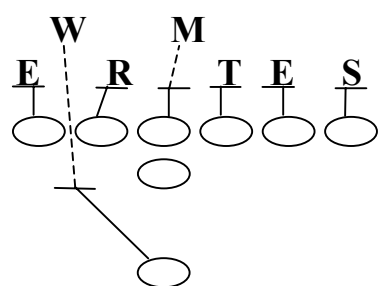

64 Under

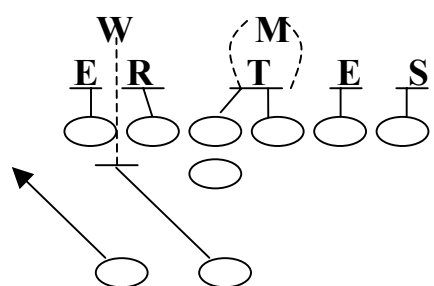

SPRINT RIGHT/LEFT PROTECTION

Assignments: (Movement)

- TE – On Side – Free Release Backside – Step, Slide, Step and Gate
- RT – On Side – Seal B Gap Backside – Step, Slide, Step and Gate
- RG – On Side – Covered – Reach B Gap, Uncovered – Seal A Gap Backside – Step, Slide, Step and Gate
- C – Step, Slide, Step and Gate
- LG – On Side – Covered – Reach B Gap, Uncovered – Seal A Gap Backside – Step, Slide, Step and Gate
- LT – On Side – Seal B Gap Backside – Step, Slide, Step and Gate
- FB – Seal E.M.O.L.
- HB – Free Release or Scan block the backside

43 Over

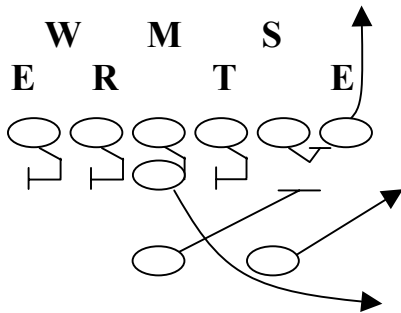

43 Under

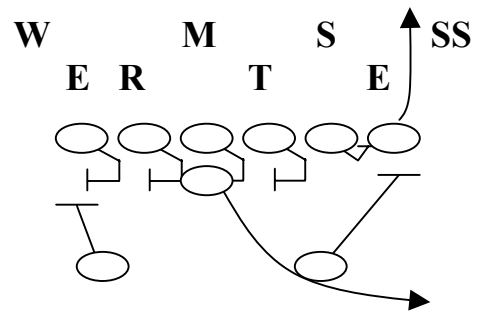

54

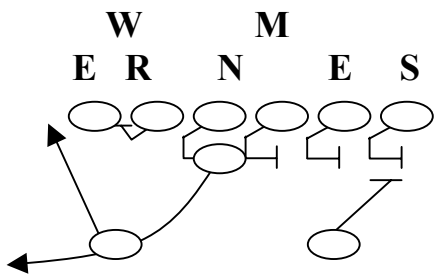

55 Over

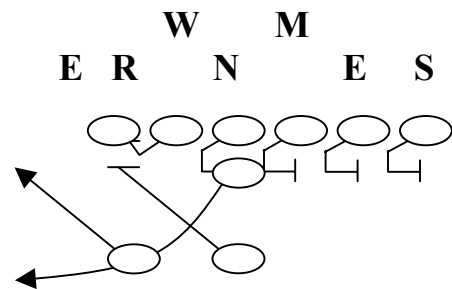

64 Over

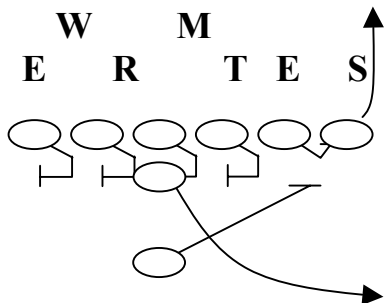

64 Under

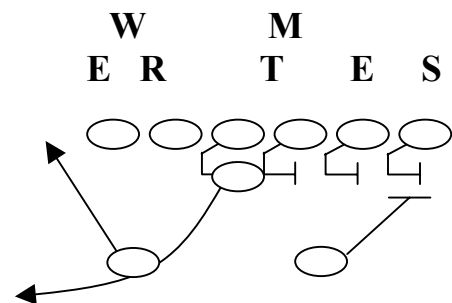

2 (3) JET PROTECTION

Assignments: (5-7 Step – Drop Back)

TE – Free Release

RT – Covered – Big Man Uncovered – Fan

RG – Covered – Big Man Uncovered – “Duel” call

C – Covered – Big Man Uncovered – “Heavy” call possible

LG – Covered – Big Man Uncovered – “Duel” call

LT – Covered – Big Man Uncovered – Fan

FB – Double Read MDM to Call Side

HB – Free Release to Call Side (Alert for outside Blitz)

QB – Hot off first strong side backer

43 Over

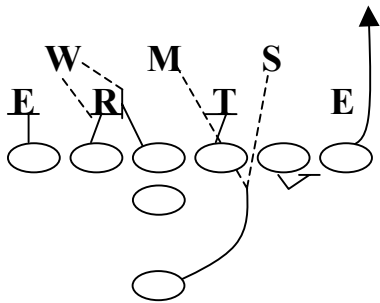

43 Under

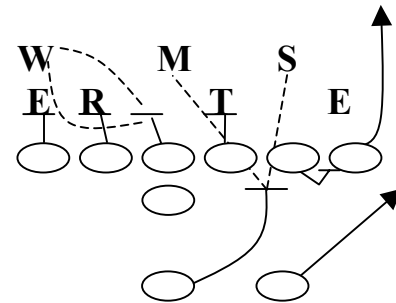

54

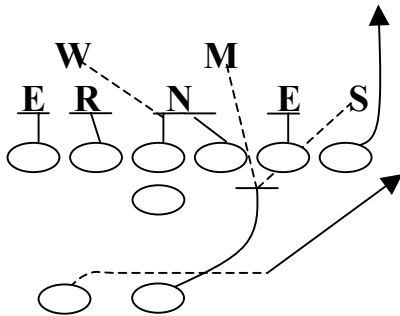

55 Over

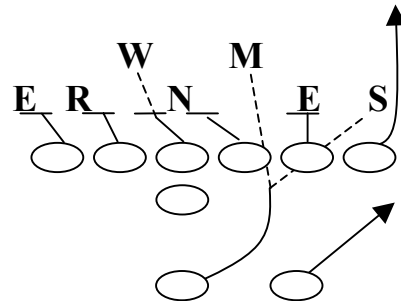

64 Over

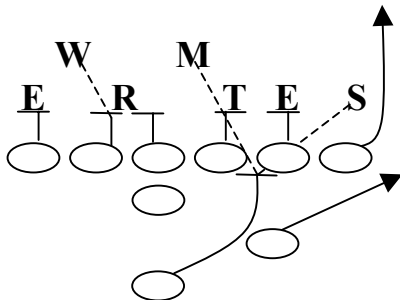

64 Under

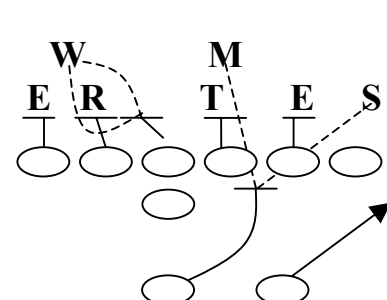

312/313 PROTECTIONS

Assignments: (Play Action)

TE – Block 22 Iso Pass Pro Assignment

RT – Block 22 Iso Pass Pro Assignment

RG – Block 22 Iso Pass Pro Assignment

C – Block 22 Iso Pass Pro Assignment

LG – Block 22 Iso Pass Pro Assignment

LT – Block 22 Iso Pass Pro Assignment

FB – Fake 22 – Blast thru A Gap Run Option Route

HB – Fake 22 – Blast thru A Gap Run Check Down

QB – Good Fake!

43 Over

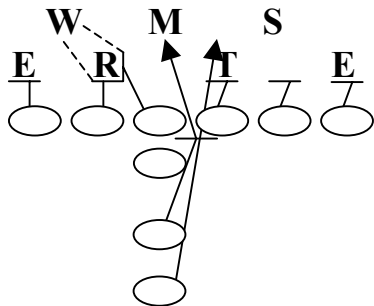

43 Under

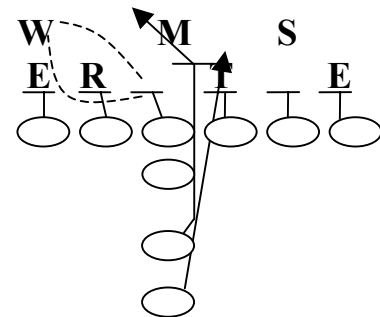

54

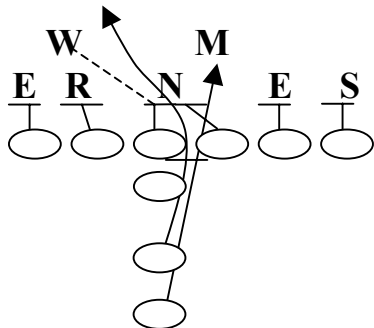

55 Over

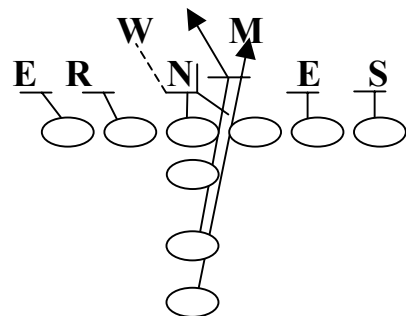

64 Over

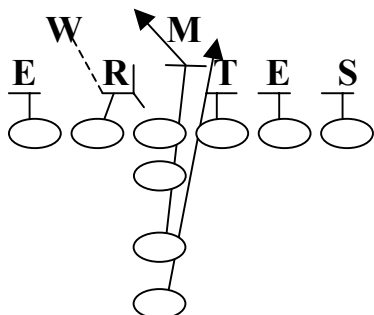

64 Under

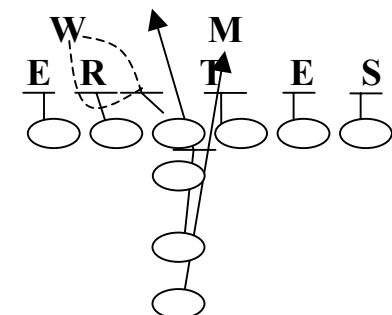

Assignments: (Aggressive Play Action)

TE – Release

RT – Onside Covered – Big Man Uncovered – Fan Backside Covered – Big Man Uncovered - Fan

RG – Covered – Big Man Uncovered – Combo “Ace”

C – Covered – Big Man Uncovered – Combo “Ace” call to Backside Guard

LG – Covered – Big Man Uncovered – Combo “Ace”

LT – Onside Covered – Big Man Uncovered – Fan Backside Covered – Big Man Uncovered - Fan

FB – Block Lead

HB – Run Lead course, key first LB inside strong

43 Over

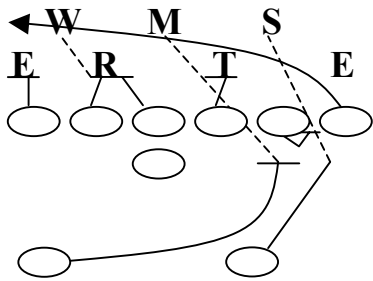

43 Under

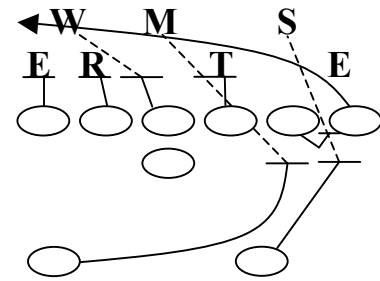

54

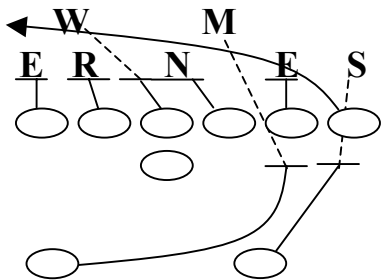

55 Over

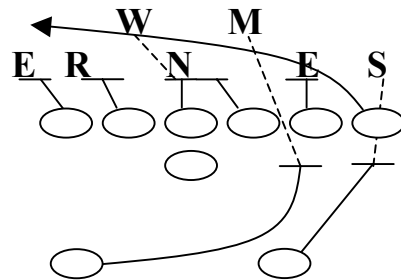

64 Over

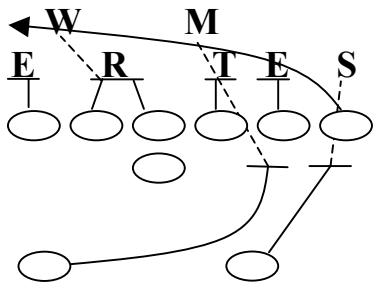

64 Under

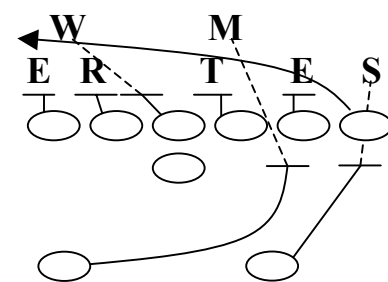

28 (29) PROTECTION

Assignments: (Drop Back)

TE – Big Man – “Alert” call if outside pressure

RT – Big Man – “Deuce” call to FB vs. 64 Over

RG – Covered – Big Man “Deuce” call to FB vs. 64 Over

Uncovered – “Ace” call

C – Covered – Big Man Uncovered – “Ace” call

LG – Covered – Big Man “Deuce” call to FB vs. 64 Over

Uncovered – “Ace” call

LT – Big Man – “Deuce” call to HB vs. 64 Over

FB – Key SS

HB – Key Outside LB Weak

43 Over

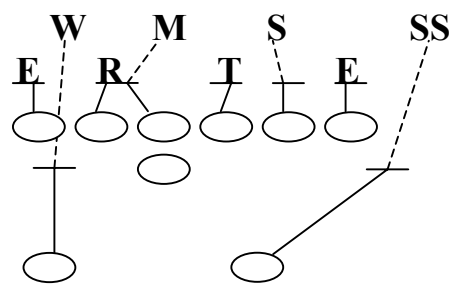

43 Under

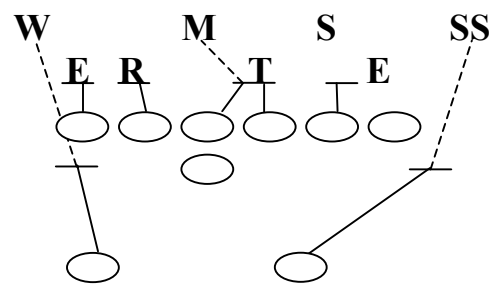

54

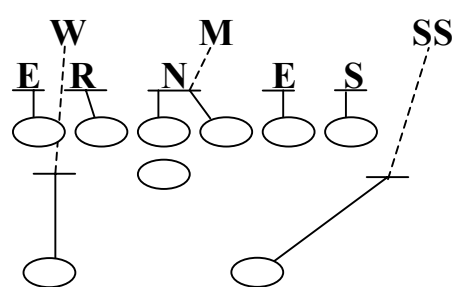

55 Over

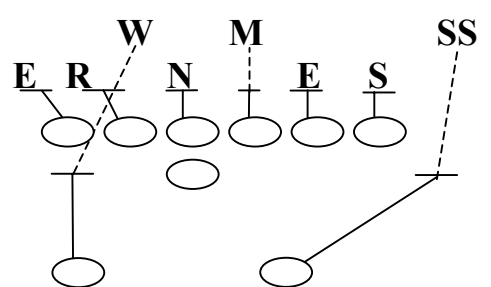

64 Over

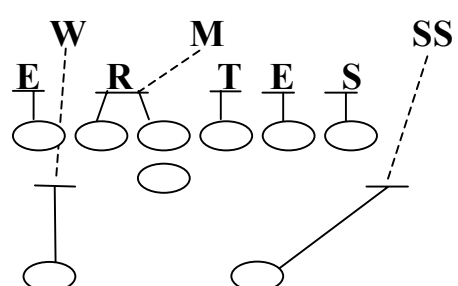

64 Under

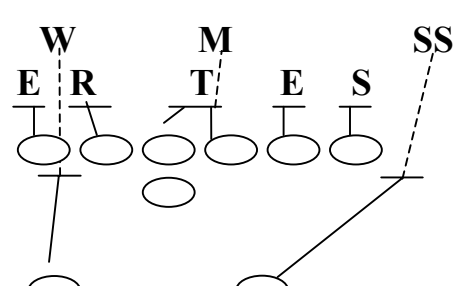

SCAT PROTECTION

Assignments: (Drop Back)

TE – Release

RT – Big Man

RG – Covered – Big Man Uncovered – “Ace” call

C – Covered – Big Man Uncovered – “Ace” call

LG – Covered – Big Man Uncovered – “Ace” call

LT – Big Man

HB – Free Release

43 Over

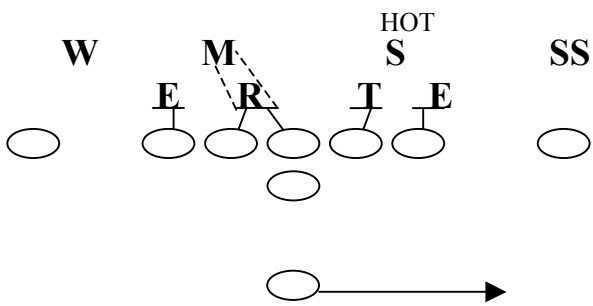

43 Under

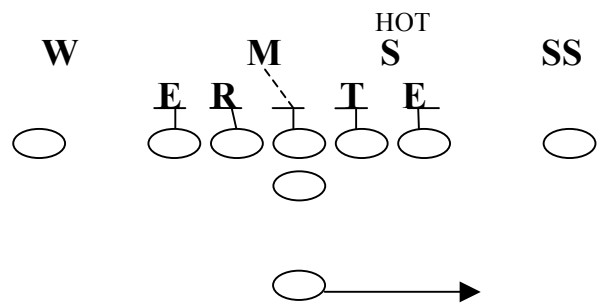

54

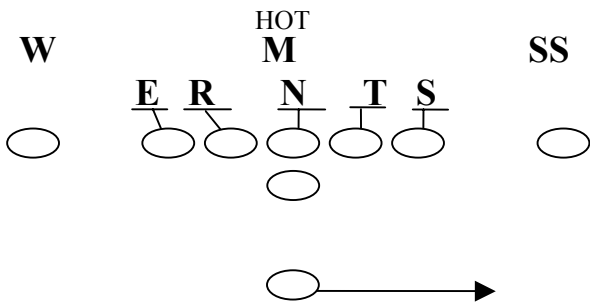

55 Over

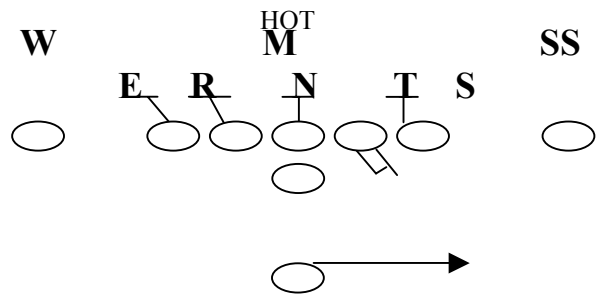

64 Over

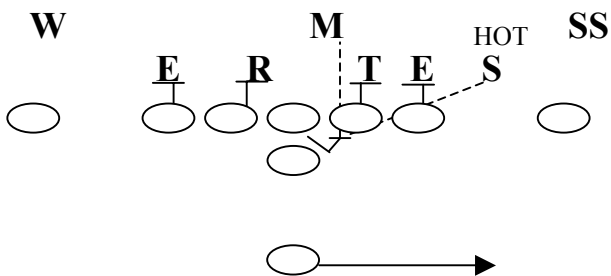

64 Under

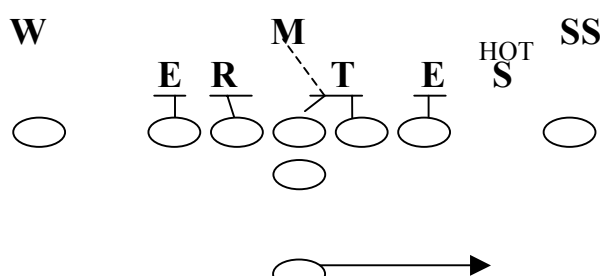

FAKE 94 (95) (QB KEEP) PROTECTION

Assignments: (Movement)

TE – Inside Release – Over Route

RT – Playside Gap

RG – Playside Gap

C – Playside Gap

LG – Playside Gap

LT – Playside Gap

FB – Chip and Release

HB – Make a good fake of 94/95 and block #1 outside the tackle

QB – Great Fake!

43 Over

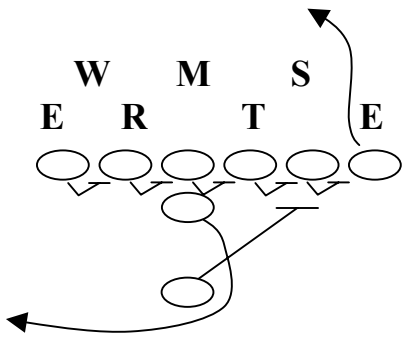

43 Under

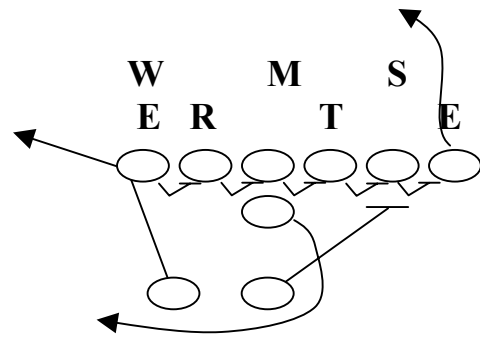

54

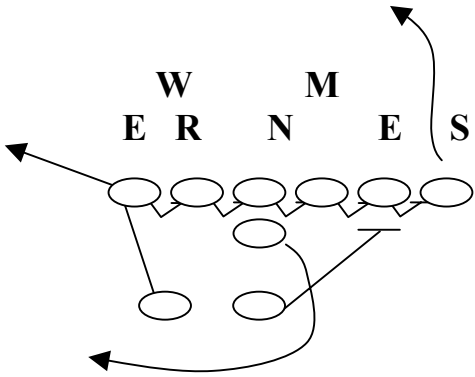

55 Over

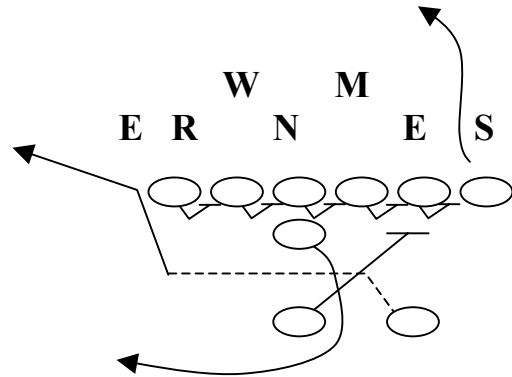

64 Over

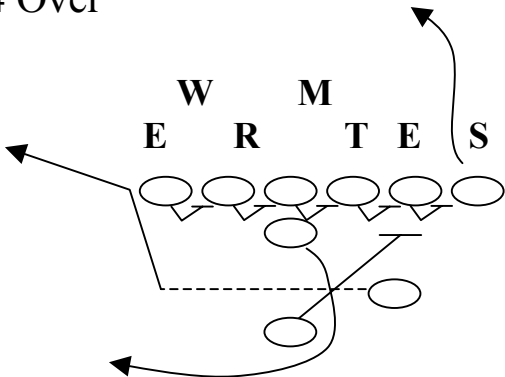

64 Under

